

# User Manual

(Part 1405-PK-200, Heated)

(Part 1405-PK-300, non-Heated)



**Applies to units with Serial Number 16100001 onwards  
with Firmware 2368-109-01 onwards**

Gill Instruments Limited  
Saltmarsh Park, 67 Gosport Street, Lymington,  
Hampshire, SO41 9EG, UK  
Tel: +44 1590 613500, Fax: +44 1590 613555  
Email: [anem@gillinstruments.com](mailto:anem@gillinstruments.com) Website: [www.gillinstruments.com](http://www.gillinstruments.com)

## Table of Contents

|   |           |
|---|-----------|
| <b>1. Welcome to the Windsonic M user manual .....</b>                                      | <b>4</b>  |
| 1.1. Overview of Content.....   | 4         |
| 1.2. Description of Icons .....   | 4         |
| 1.3. General Notes.....   | 5         |
| 1.4. User Manual Revision History .....   | 5         |
| <b>2. Product Overview.....</b>   | <b>6</b>  |
| <b>3. Pre-Installation.....</b>   | <b>7</b>  |
| 3.1. Equipment supplied.....  | 7         |
| 3.2. Windsonic M Accessories .....  | 7         |
| 3.3. Windsonic CE, UKCA, FCC conformity .....   | 8         |
| 3.4. Right to change and revise .....   | 8         |
| 3.5. Packaging .....  | 8         |
| 3.6. Windsonic M Specification .....  | 8         |
| 3.7. Downloadable Software .....  | 8         |
| 3.8. WindSonic Part Numbers .....   | 9         |
| <b>4. Requirements &amp; Installation.....</b>  | <b>9</b>  |
| 4.1. Installation requirements .....  | 9         |
| 4.2. Installation Guidelines .....  | 10        |
| 4.3. Bench system test.....   | 11        |
| 4.4. Electrical .....   | 11        |
| 4.4.1. Cable .....  | 11        |
| 4.4.2. Cable Length .....   | 12        |
| 4.4.3. Power Supply .....   | 12        |
| 4.4.4. For the Heated WindSonic M variant: - .....  | 12        |
| 4.5. Connecting to a PC using RS232 (Default Sensor) .....                                  | 13        |
| 4.6. Connecting an RS422 output WindSonic M to a PC with an RS422 Interface/Converter. .... | 14        |
| 4.7. Using 2 Wire RS485 Point to Point Only .....   | 15        |
| 4.8. Analogue Output .....  | 16        |
| <b>5. Mechanical .....</b>  | <b>16</b> |
| 5.1. Orientation .....  | 16        |
| 5.2. Alignment .....  | 16        |
| 5.3. Mounting .....   | 16        |
| 5.4. Earthing or Grounding .....  | 19        |
| 5.5. Heating .....  | 19        |
| <b>6. Message Formats .....</b>   | <b>20</b> |
| 6.1. Gill format– Polar, Continuous (Default format).....                                   | 20        |
| 6.2. Gill format – UV, Continuous.....  | 22        |
| 6.3. NMEA Format (NMEA status codes).....   | 24        |
| 6.4. NMEA Format (Gill status codes).....   | 25        |
| 6.5. Gill format – Tunnel Mode (UU, Continuous).....  | 26        |
| 6.6. Analogue Outputs and Options .....   | 26        |

---

|  |    |
|--|----|
| Appendix A - Technical Specification .....     | 27 |
| Appendix B - Cable Assembly .....              | 29 |
| Appendix C - Windsonic Safe mode .....         | 33 |
| Appendix D – Configuring .....                 | 36 |
| Appendix E – Polled Mode Commands .....        | 49 |
| Appendix F - Wind View Software.....           | 50 |
| Appendix G - Status Codes.....                 | 55 |
| Appendix H - Maintenance & Fault-Finding ..... | 56 |
| Appendix I - Glossary & Abbreviations.....     | 59 |
| Appendix J - Guarantee & FCC .....             | 60 |

# 1. Welcome to the Windsonic M user manual

## About this manual

This manual provides the information needed to get the best results from Windsonic M. The most recent version of this manual is available at [gillinstruments.com](http://gillinstruments.com).

**Please read this manual before setting up and installing Windsonic M.**



### 1.1. Overview of Content

The manual is split into 7 chapters. Each chapter represents an activity in the use of the product. Additional detailed information is contained in the Appendices at the end of the manual.

- Chapter 1 explains how the manual is set out
- Chapter 2 provides a brief overview of the product
- Chapter 3 provides the information needed to fast set-up the product
- Chapter 4 provides the information needed to pre-install the product
- Chapter 5 provides the information needed to install the product
- Chapter 6 provides mechanical guidance for product and mounting bracket
- Chapter 7 explains message formats

### 1.2. Description of Icons

The following icons are used in this manual.

| Icon  | Description  |
|---|--|
|  | A note that is important and that should be observed   |
|  | Information or a recommendation to ensure best results |
|  | The start of a set of instructions                     |

### 1.3. General Notes



Before Windsonic M is used for the first time it is essential to read and understand this manual. Please keep the manual safe for future reference.



Care should be taken with Windsonic M at all times. The product should be transported to site in the box, and only removed when ready to install.



During installation Windsonic M should be supported and care should be taken not to drop the product



Care should be taken when wiring the Windsonic M to power and communications.



Maintenance should be limited to the procedures described in this manual. Additional maintenance or cleaning may damage the sensors.



No attempt should be made to open or repair any of the parts of the product. Any attempt to dismantle any part of the product will invalidate the warranty provided by Gill Instruments.

### 1.4. User Manual Revision History

| Document Version | Release Date | Key Changes            |
|------------------|--------------|------------------------|
| Iss 6            | Feb 2023     | Update to new template |

## 2. Product Overview

With an impressive robust, corrosion-free, aluminium alloy housing and optional anti-icing heating system the WindSonic M wind sensor is recommended for use in harsh environmental industrial conditions and is particularly suited to marine, offshore (ships, data buoys) and land-based installations.

The Gill WindSonic M wind sensor has no moving parts, outputting wind speed and direction. The units of wind speed, output rate and formats are all user selectable.

The WindSonic M can be used in conjunction with a PC, data logger or other device, provided it is compatible with one of the standard communication formats provided by the WindSonic M.

WindSonic M may be configured using Wind software, which is available, free of charge, from the Gill website [www.gillinstruments.com](http://www.gillinstruments.com). The output message format can be configured in Gill format, in Polar or UV (2-axis) format, and to either Polled (requested by host system) or Continuous output. Alternatively, it can be configured in NMEA (0183 Version 3). These are described in Section 6 Message Formats.

The WindSonic M is available with or without a Heating system.

### 3. Pre-Installation

#### 3.1. Equipment supplied

| Item  | Quantity |
|---|----------|
| WindSonic M   | 1        |
| 1405-PK-111 connector and Mounting kit consisting of: |          |
| 9 Way Connector Body                                  | 1        |
| Connector Contacts                                    | 9        |
| Connector Sealing Gland                               | 1        |
| Connector Sealing Washer                              | 1        |
| Mounting Screws – M5 stainless steel                  | 3        |
| Mounting Screw M5 Washer shake proof                  | 3        |
| Earthing Screw – M4 x 6 Stainless                     | 1        |
| Earthing Shakeproof Washer, M4                        | 1        |
| Earthing Ring Terminal Tag, M4                        | 1        |

#### 3.2. Windsonic M Accessories

A range of accessories is available to support Windsonic M. A list of accessories is shown below.

More information, and the most up to date list of accessories can be found at [gillinstruments.com](http://gillinstruments.com).

| Accessory  | Gill Instruments Part Number |
|--|------------------------------|
| Cable 4 Pair, twisted and shielded 24 AWG  | 026-03156                    |
| Cable 3 Pair, twisted and shielded 24AWG   | 026-02660                    |
| Cable 15 metres (4 twisted pairs (seven contact wires), shielded 24AWG – Seven Connector pins attached to one end and eight stripped wires the other). | 1405-10-080                  |
| WindSonic M connector (1 supplied as standard see above)   | 1405-PK-069                  |
| WindSonic M Support Tube 0.5 metre (Aluminium)   | 1405-30-056                  |
| Bracket for mounting to a Pole, includes a WindSonic Adaptor   | 1771-PK-115                  |

### 3.3. Windsonic CE, UKCA, FCC conformity

This product carries the CE and UKCA marks. A copy of the Declaration of Conformity can be downloaded from [gillinstruments.com](http://gillinstruments.com).

Note: This equipment has been tested and found to comply with the limits for a Class A digital device, pursuant to part 15 of the FCC Rules. These limits are designed to provide reasonable protection against harmful interference when the equipment is operated in a commercial environment. This equipment generates, uses, and can radiate radio frequency energy and, if not installed and used in accordance with the instruction manual, may cause harmful interference to radio communications. Operation of this equipment in a residential area is likely to cause harmful interference in which case the user will be required to correct the interference at his own expense.

### 3.4. Right to change and revise

Gill Instruments reserve the right to change or revise the product without notice or the obligation to notify any person or organisation of such change or revision.

Gill Instruments reserve the right to change or revise the information supplied in this manual without notice or the obligation to notify any person or organisation of such change or revision.

The reproduction and distribution of the documentation and software supplied with this product and the use of its contents is subject to written authorization from Gill Instruments.

### 3.5. Packaging

Whilst the WindSonic M is being moved to its installation site, the unit should be kept in its inner packaging. All the packaging should be retained for use if the unit has to be returned at any time, or if a self-test is performed.

### 3.6. Windsonic M Specification

The Windsonic M Specification can be found in Appendix A

### 3.7. Downloadable Software

Two software packages are available to help customers use Windsonic M.

- Wind - this software can be used to set-up the product
- Wind View - this software can be used to view the data provided by the product

Both software packages can be downloaded from [gillinstruments.com](http://gillinstruments.com).



### 3.8. WindSonic Part Numbers

**1405-PK-200 WindSonic M –Heating, RS 232 output (default)**

**1405-PK-300 WindSonic M –No Heating, RS 232 output (default)**

## 4. Requirements & Installation

### 4.1. Installation requirements

**Host system** - Use of the following:

- PC fitted with a suitable interface to match the chosen communication format (RS232, RS422, or RS485 (point to point), compatible with the WindSonic M output protocol selected, and a suitable Terminal Emulation software package. For example, TeraTerm, puTTY or Wind Software that is available from the Gill website at <https://gillinstruments.com/downloads/>

Other equipment with input/output compatibility to the WindSonic M.

For example, Data loggers.

**Cable** - To connect between the WindSonic M and the host system

*See Section 4.4.1 Cable type for cable specification.*

- There are restrictions on the maximum cable lengths for correct operation.
- The cable should be routed up the inside of the mounting tube.

**Mounting tube (e.g., 0.5-metre-long Gill part 1405-30-056)**

- Standard tube 1.75 inches (44.45mm) Outside Diameter x 3mm wall thickness.
- **Note: it is important that the correct diameter tube is used to prevent damage to the WindSonic lower moulding when tightening the screws.**

*See Figure 3, Alignment & Mounting Details on page 20.*

- For non-hostile environments, Aluminium tube can be used.
- For hostile environments, you should select a material suitable for the intended environment. For example, stainless steel 316 for marine use.

**Mounting Bracket (Gill Part 1771-PK-115)**



**Do NOT remove the black “rubber” transducer caps. Warranty is void if the coloured security seal is damaged or removed.**

## 4.2. Installation Guidelines

The WindSonic M has been designed to meet and exceed the stringent standards listed in its specification. Operating in diverse environments all over the world, WindSonic M requires no calibration and adjustment whatsoever.

As with any sophisticated electronics, good engineering practice should be followed to ensure correct operation.

- Always check the installation to ensure the WindSonic M is not affected by other equipment operating locally, which may not conform to current standards, e.g., radio/radar transmitters, boat engines, generators etc.  
Guidelines –
- Avoid mounting in the plane of any radar scanner – a vertical separation of at least 2m should be achieved.
- Radio transmitting antennas, the following minimum separations (all round) are suggested.
  - ❖ VHF IMM – 1m
  - ❖ MF/HF – 5m
  - ❖ Satcom – 5m (avoid likely lines of sight)
- Use cables recommended by Gill. If cables are cut and re-connected incorrectly (perhaps in a junction box) then EMC performance may be compromised if cable screen integrity is not maintained.
- Earth loops should not be created – wire the system in accordance with the installation guidelines.
- Ensure the power supply operates to the WindSonic M specification at all times.

Avoid turbulence caused by surrounding structures that will affect the accuracy of the WindSonic M such as trees, masts, and buildings. Ideally sensors should be mounted on the prevailing wind side of the site.

The WMO make the following recommendations:

The standard exposure of wind instruments over level open terrain is 10m above the ground. Open terrain is defined as an area where the distance between the sensor and any obstruction is at least 10 times the height of the obstruction.

If mounting on a building, then theoretically the sensor should be mounted at a height of 1.5 times the height of the building.

If the sensor is to be mounted on a mast boom, part way up a tower or mast, then the boom should be at least twice as long as the minimum diameter or diagonal of the tower. The boom should be positioned on the prevailing wind side of the tower.

### 4.3. Bench system test



Prior to physically mounting the WindSonic M in its final location, we strongly recommend that a bench system test is carried out to confirm the system is configured correctly, is fully functional and electrically compatible with the selected host system and cabling (preferably utilising the final cable length). The required data format, units, output rate, and other options should also all be set up at this stage.

### 4.4. Electrical

#### 4.4.1. Cable

A RS422 compatible cable should be used, with the number of twisted pairs matching the application.

**Generic description** – Twisted pairs with drain wire, screened with aluminised tape, with an overall PVC sheath of 6mm-12mm outer diameter. Wire size 7/0.2mm (24 AWG).

The table shows some suitable manufacturers’ references; other manufacturers’ equivalents can be used.

#### WindSonic M, Non-Heated

| Application | No. of pairs | Gill ref.<br>24 AWG | Belden ref.<br>24 AWG | Batt electronics ref.<br>24 AWG |
|-------------|--------------|---------------------|-----------------------|---------------------------------|
| RS 232      | 3            | 026-02660           | 9730                  | 91030                           |
| RS 422      | 4            | 026-03156           | 9728                  | 91199                           |

#### WindSonic M, Heated

Thicker or higher specification cable can be used up to 20 AWG. If long cables are used, then consideration should be given to powering the Heater using lower 20 AWG gauge wire or paralleling heater and sensor power cables (24v dc supply only) to reduce volt drops.

Alternatively locate the sensor/heater supply as close as possible to the unit and run data only over the longer cable distances.

| Application | No. of pairs | Gill.<br>24 AWG | Belden.<br>24 AWG | Batt electronics.<br>24 AWG |
|-------------|--------------|-----------------|-------------------|-----------------------------|
| RS 232      | 4            | 026-03156       | 9728              | 91199                       |
| RS 422/485  | 6            | 026-02661       | 9731              | 91031                       |

#### 4.4.2. Cable Length

The maximum cable length is dependent on the chosen communication format (RS232, RS422 or RS485 (point to point), the baud rate, and, to a lesser extent, on the cable type and the local electrical 'noise' level.

The table shows the typical maximum lengths at the given baud rates, using the recommended cable. If any problems of data corruption etc. are experienced, then a slower baud rate should be used. Alternatively, a thicker or higher specification cable can be tried

| Communication format  | Baud rate | Max. cable length |
|-----------------------|-----------|-------------------|
| RS232                 | 9600      | 6.5 m (20 ft)     |
| RS422 or 485 (P to P) | 9600      | 1km (3200 ft)     |

#### 4.4.3. Power Supply

WindSonic M Sensor Supply      5V to 30V DC (30V DC max).  
 WindSonic M Sensor Current      9mA @ 12V DC (1Hz, 9600B, RS232).  
 WindSonic M Sensor Current      5.5mA @ 12v DC (0.25Hz, 9600B, RS232).

#### 4.4.4. For the Heated WindSonic M variant: -

Heater Power                      10V to 30.0V DC.  
 Heater Power                      24V rms AC ± 10 % @50/60Hz.  
 Heater Current                    Allow for 2.2 Amps @ 12V DC (nominal supply), 26W max.  
 Heater Current                    Allow for 4.2 Amps @24v AC or DC (nominal supply) 100W max.  
 Heater Current                    Non activated standby current approximately 40mA.

A 24v dc Heater Supply capable of a minimum of 6 Amps is recommended for initial heating start up surge.

Note that the Heater supply is isolated from the Sensor supply.

However, it is permissible to connect a common 24v dc supply to both the Sensor supply connections and Heater supply connections if required.

Neither the Sensor supply connections nor the Heater supply connections should be connected to the WindSonic M metal case.

Heater Cable length should be minimised to avoid cable volt drops and ensure maximum voltage is received at the Anemometer.

If necessary, parallel up spare wires in the cable and connect to the heater pins in order to reduce volt drops.

There is no heating command on the heated WindSonic M, heating is enabled by internal temperature sensing devices and cannot be disabled except by removing the heater supply.

The WindSonic M has reverse polarity protection.

### 4.5. Connecting to a PC using RS232 (Default Sensor)

1. Some PCs have a Serial RS232 interface and a suitable terminal emulation package already installed, which can easily be utilised with the WindSonic M. (Terminal Program). Otherwise use Gill Wind Software.
2. The cable length for reliable operation is limited to 6.5m (20ft).  
(See Section 4.4.1 Cable length.)
3. For longer cable runs, we recommend using the WindSonic M configured with RS422 output, and a RS422/232/USB converter at the PC. See section 4.7 (**Error! Reference source not found.Converter**).

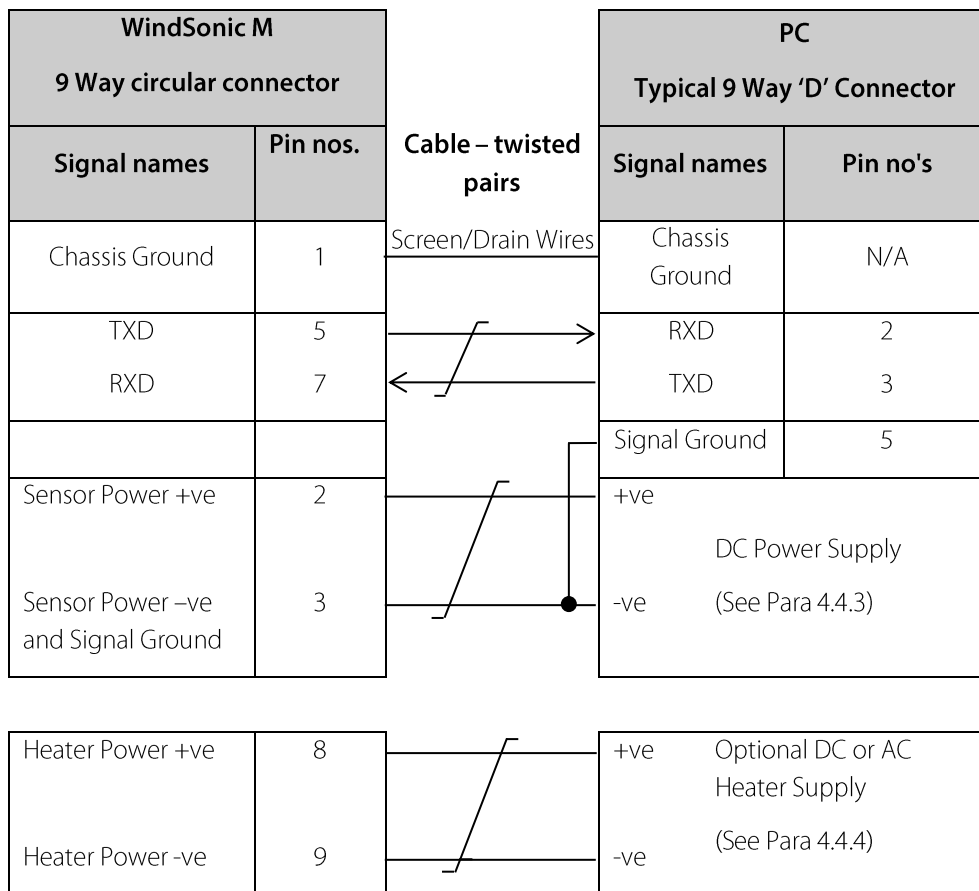

#### Default Settings

The WindSonic M unit is factory configured with the following default settings:

**M2, U1, O1, L1, P1, B3, H1, NQ, F1, E3, T1, S4, C2, G0, K50**

4.6. Connecting an RS422 output WindSonic M to a PC with an RS422 Interface/Converter.



WindSonic M must be set for RS422/RS485 mode (E2).

Wiring connections below are not the same as a standard WindSonic Option 2 or 3 unit.

For further details on how to change a WindSonic M from the Default Set RS232 Output (Mode E3) to RS422 Output (Mode, E2) please see Appendix C (Safe Mode)

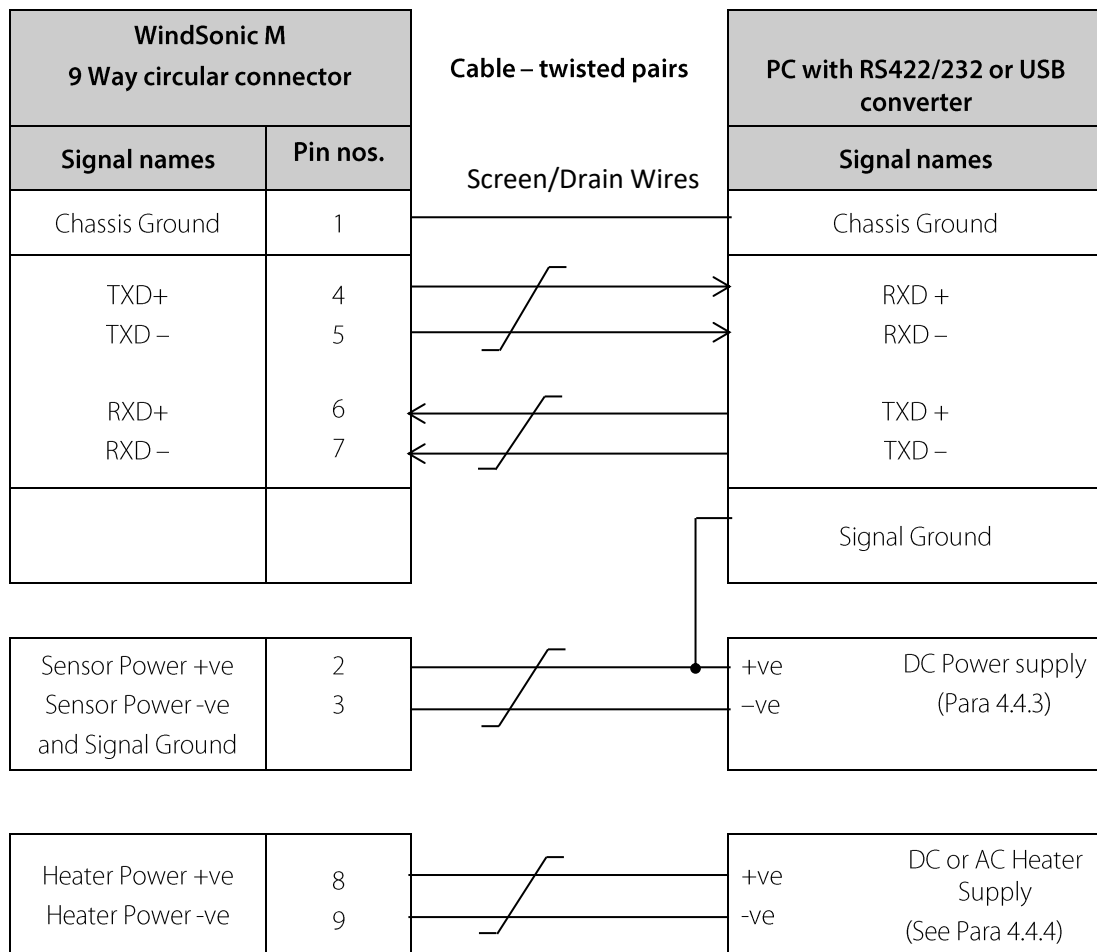

4.7. Using 2 Wire RS485 Point to Point Only



1. **The unit must be set for RS422/485 mode (E2 setting).**
2. **WindSonic M must be set in Polled mode;** a node address letter may be given if required.  
*See Section 6.1 WindSonic M node address.*
3. Customers may poll using terminal software (NOT supplied).
4. **Wiring connections below are not the same as a standard WindSonic Option 2 or 3 unit.**

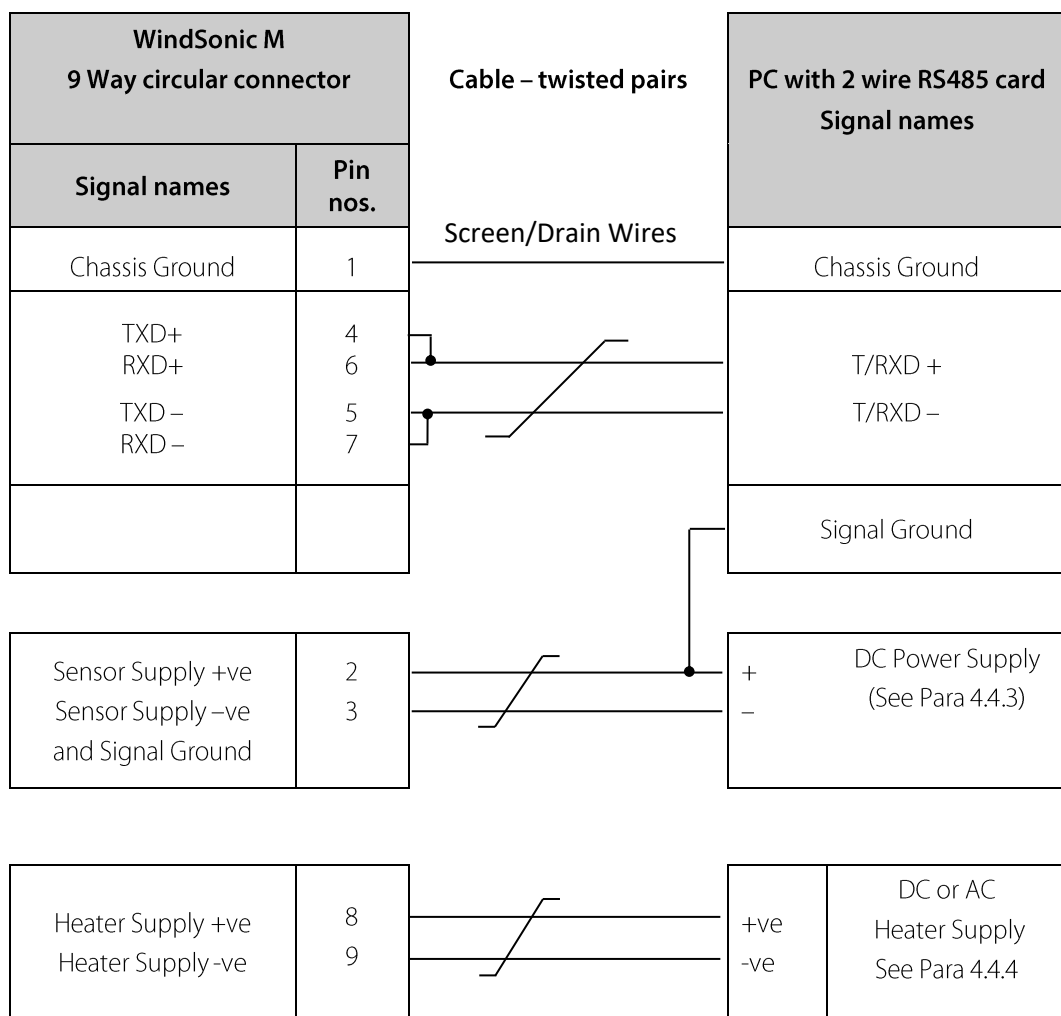

## 4.8. Analogue Output



Analogue Outputs are not available from WindSonic M Sensors 1405-PK-200 and 1405-PK-300.  
For Analogue outputs refer to WindSonic M Sensors 1405-PK-201 and 1405-PK-301.

## 5. Mechanical



*Before installing, see note at Appendix H Bench system test.*

### 5.1. Orientation

Normally the WindSonic M is mounted on a vertical tube, ensuring a horizontal Measuring Plane.

*See Figure 3 Alignment & Mounting details*

For indoor use the unit may be mounted with the Measurement Plane set to any required orientation.

### 5.2. Alignment

The WindSonic M should be aligned to point to North, or any other reference direction –for example, the bow of a boat. There are three notches aid north alignment.

*See Figure 3 Alignment & Mounting Details*

**Note:** It is usually simpler to work first with a compass at ground level and identify a suitable landmark and its bearing.

### 5.3. Mounting

The support tube requires three 3 equally spaced holes, tapped M5, 7.5mm from the top of the tube. Pass the cable (fitted with the 9-way Clipper plug) through the tube.

**Note:** the customer must fit appropriate strain relief to the cable.

Connect the plug by twisting it whilst pushing it gently into the socket on the WindSonic M. When it locates, twist the outer sleeve clockwise to connect and lock the plug.

Fix the WindSonic M to the tube using the 3 stainless steel screws provided. (Maximum mounting screw torque 4 Nm.)

It is the responsibility of the customer to ensure that the WindSonic M is mounted in a position clear of any structure, which may obstruct the airflow or induce turbulence.



**Do NOT mount the WindSonic M in close proximity of high-powered radar or radio transmitters. A site survey may be required if there is any doubt about the strength of external electrical noise.**



**Mounting Bracket** (1771-PK-115)

Mount the Sensor on to the bracket mount and if using a Wind Sensor align so that the Sensor North Marker points to the bracket pole.

Secure the sensor to its mount using screws and washers supplied in the Sensor Box.

Torque screws to a maximum of 4 Nm.

The Bracket uses a clamp suitable for attaching to a vertical pipe with a diameter of 30-58mm. When mounting the Bracket Sensor, consider the position, orientation, and alignment of the unit. Mount at the top of a Pipe to ensure a clear unobstructed measurement view.

Note that the mounting pipe should first be degreased and when assembling the Bracket clamp assembly, the outer clamp nuts need to be tightened evenly to a torque figure of 3 Nm.

The moving plate part of the clamp needs to be reversed for poles below 38 mm diameter.

Screw an Earth cable minimum of 6mm<sup>2</sup> to the Bracket chassis using Screw and Terminal Tag fixings supplied.

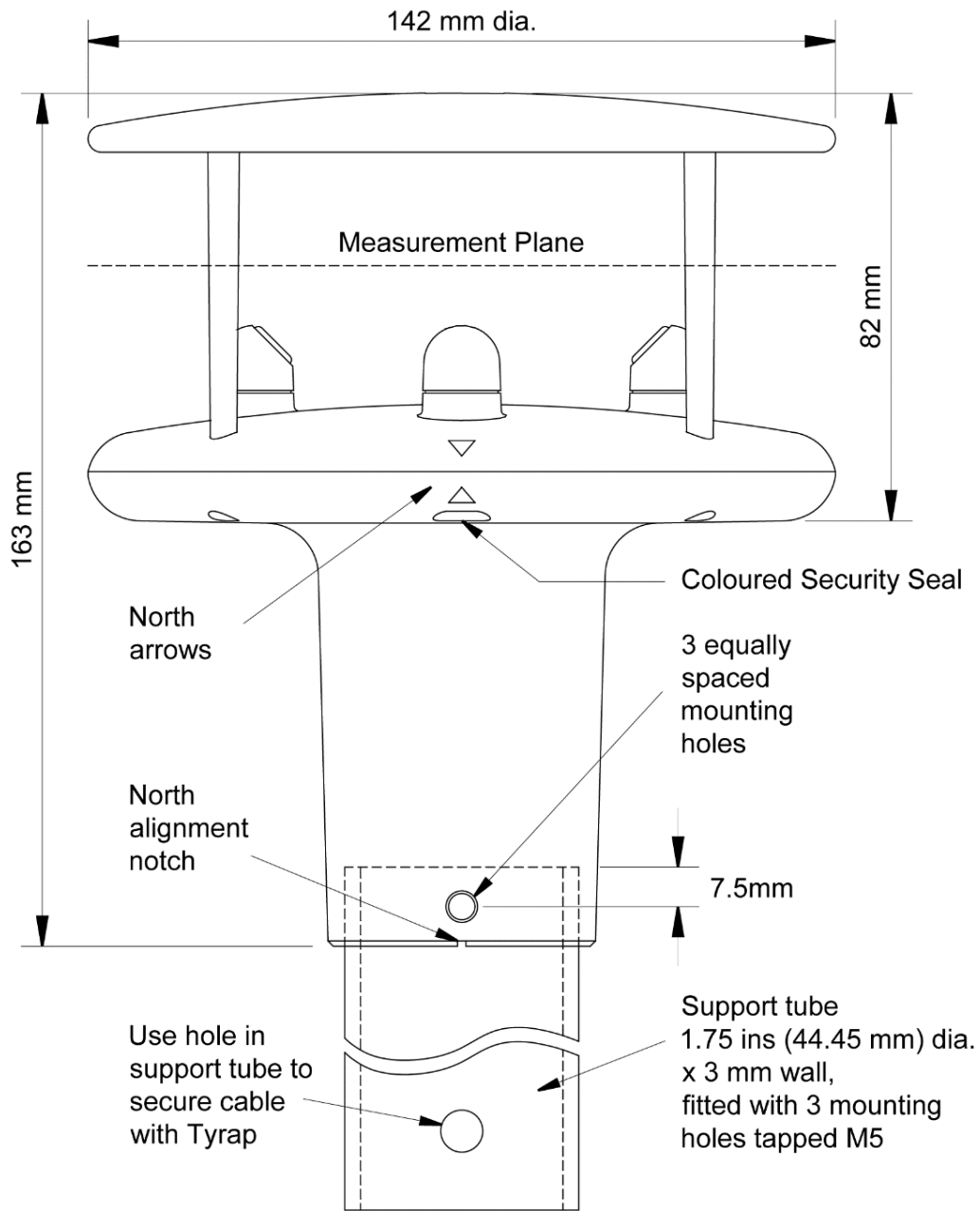

Gill Instruments 0.5 Metre Aluminium support tube is supplied with drilled and tapped M5 holes as above, part number 1405-30-056.

Figure 3 Alignment & Mounting details

## 5.4. Earthing or Grounding



**To ensure correct operation, and for maximum protection against lightning, the anemometer metalwork MUST be correctly earthed (grounded) to an appropriate grounding point.**

The primary earth for the anemometer must be made using the M4 Earthing Point provided via a minimum of 6mm<sup>2</sup> copper wire to the ground point.

Remove the M4 Nylon screw from the mounting body of the WindSonic M and insert the M4 x 6 Earth Screw/Shakeproof Washer/Ring Terminal lead connection and secure as shown below.

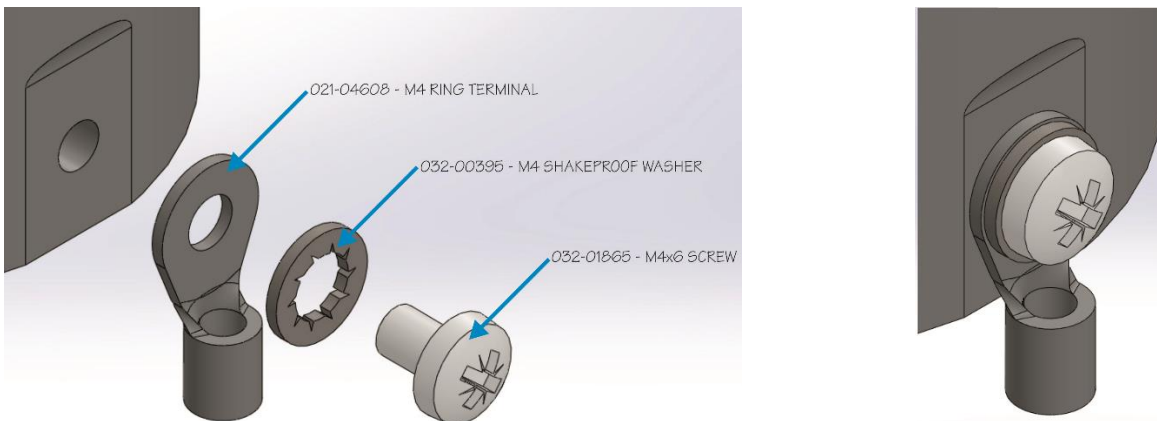

The 3 screws securing the anodised WindSonic M body to a Grounded metal pole/mast cannot be relied on to provide a good ground connection.

Inadequate Earthing/Grounding will degrade anemometer performance, particularly in the presence of radio frequency interference.

If junction boxes are used the cable screens must be joined with any cable screen continuing from the unit's cable via the junction box.

## 5.5. Heating

The WindSonic M can be ordered with Heating (Part 1405-PK-200).

Heating is autonomous and requires no set-up; it is continuously enabled and will operate on and off depending on temperature conditions that are likely to lead to icing.

Heating is applied to the transducer plate, the transducers and the reflector plate.

Upon switching on a WindSonic M heated unit, providing heater power is connected then a one minute burst of heating will occur to give confidence that the heating is functioning.

## 6. Message Formats

On applying power to the WindSonic M, it will provide wind measurements in one of the following formats:

1. Gill – Polar, Continuous (**default format**)
2. Gill - UV, Continuous
3. Gill – Polar Polled
4. Gill – UV Polled
5. NMEA – IIMWV or WIMWV (with NMEA status Codes)
6. NMEA – IIMWV or WIMWV (with Gill Status Codes)
7. Tunnel – U Direction, U Speed

Each of these is described below.

Information on how to change the formats and settings follows in Appendix D (CONFIGURING)

### 6.1. Gill format– Polar, Continuous (Default format)

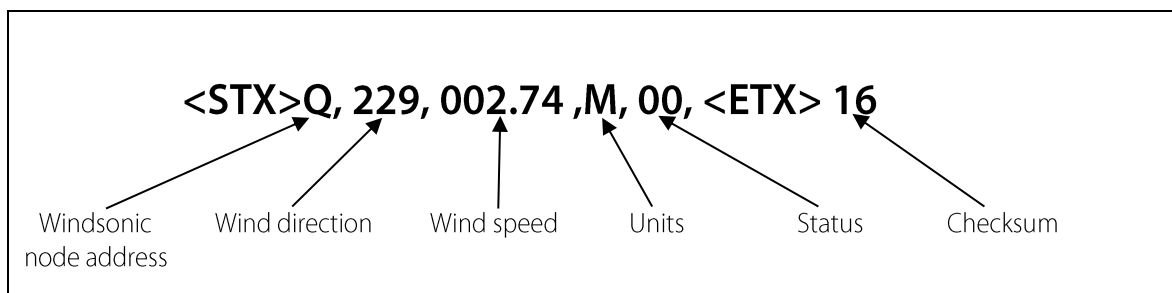

Where:

|                        |   |   |
|------------------------|---|---|
| <STX>                  | = | Start of string character (ASCII value 2)   |
| WindSonic node address | = | Unit identifier   |
| Wind direction         | = | Wind Direction  |
| Wind speed             | = | Wind Speed  |
| Units                  | = | Units of measure (knots, m/s etc.)  |
| Status                 | = | Anemometer status code (see Appendix G for further details)   |
| <ETX>                  | = | End of string character (ASCII value 3)   |
| Checksum               | = | This is the EXCLUSIVE – OR of the bytes between (and not including) the <STX> and <ETX> characters. |
| <CR>                   |   | ASCII character   |
| <LF>                   |   | ASCII character   |

### WindSonic M node address

The default setting is 'Q'. If required the WindSonic M can be configured to show a different alphabetical node letter (A to Z), so as to identify the WindSonic M.

It is recommended that ID's A to F and K, M, N and P are not used, as these characters can be present in the data string.

### Wind direction

Indicated in degrees, from 0 to 359°, with respect to the WindSonic M North marker.

Whilst the wind speed is below 0.05 metres/sec (K50), then in Comma Separated Variable mode no direction value will be output (e.g. Q,,000.03,M,00,1C). In Fixed Field mode wind direction output will freeze at the last known valid direction value (e.g. Q,133, 000.02,M,00,1A) until a new valid value can be calculated.

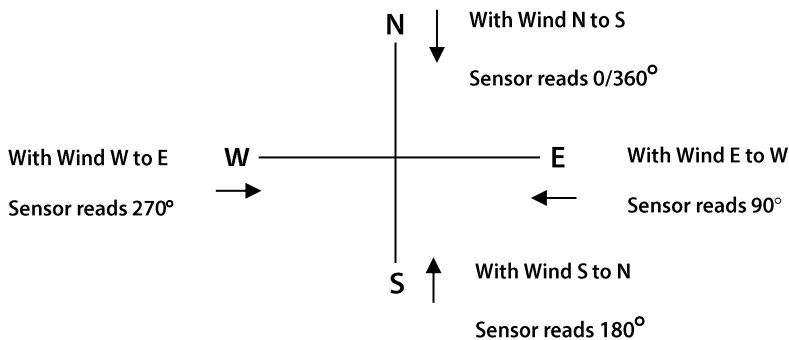

### Wind speed and units

Shows the Wind Speed in the Measurement Plane (See Figure 3 above Alignment & Mounting details) in one of the following units:

| Units                              | Identifier |
|------------------------------------|------------|
| <b>Metres per second (default)</b> | <b>M</b>   |
| Knots                              | N          |
| Miles per hour                     | P          |
| Kilometres per hour                | K          |
| Feet per minute                    | F          |

### Low Wind Speeds (below 0.05ms)

Whilst the wind speed is below 0.05 metres/sec, the wind direction will not be calculated.

In CSV mode no direction value will be output (e.g. Q,,000.03,M,00,1C). In Fixed Field mode wind direction output will freeze at the last known valid direction value (e.g. Q,133, 000.02,M,00,1A) until a new valid value can be calculated. The above applies with the K command set for K50. If K for instance is set for 100 then the above applies at 0.1m/s.

## Output Rate

The WindSonic M samples continuously and delivers wind information at ¼, ½, 1 (default setting), 2, or 4 outputs / second

## Status

This indicates either

Correct operation Code 00 and A (NMEA).

or Error codes See Section Appendix G for explanation of codes.

## Checksum

This enables the host system to check that the data has been correctly received. This is the EXCLUSIVE – OR of the bytes between (and not including) the <STX> and <ETX> characters.

### 6.2. Gill format – UV, Continuous

In this mode, the output is given as signed (i.e. positive or negative) speeds along the 'U' (= South – North) axis and the 'V' (= East – West) axis.

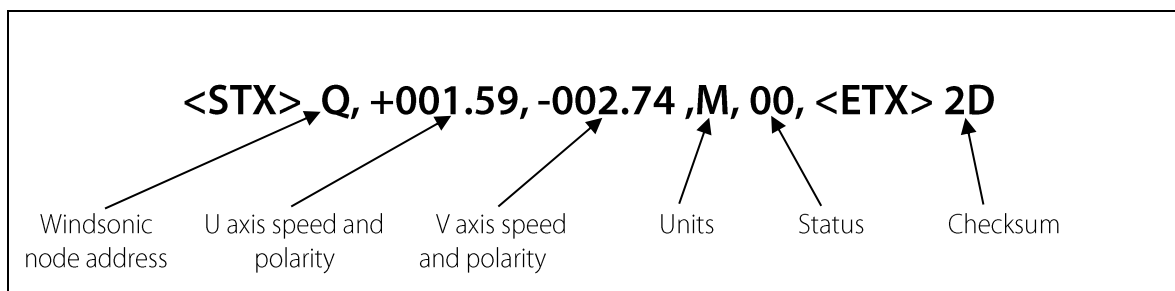

Where:

|                        |   |  |
|------------------------|---|--|
| <STX>                  | = | Start of string character (ASCII value 2)  |
| WindSonic node address | = | Unit identifier  |
| U axis                 | = | speed & polarity   |
| V axis                 | = | speed & polarity   |
| Units                  | = | Units of measure (knots, m/s etc.)   |
| Status                 | = | Anemometer status code (see Appendix G for further details)  |
| <ETX>                  | = | End of string character (ASCII value 3)  |
| Checksum               | = | This is the EXCLUSIVE – OR of the bytes between (and not including) the <STX> and <ETX> characters |

The WindSonic M unit identifier, Units, and Checksum are as described in Section 7.2 above.

**Error! Reference source not found.**5 shows the polarity of U and V if the wind components along the U and V axis are blowing in the direction of the respective arrows.

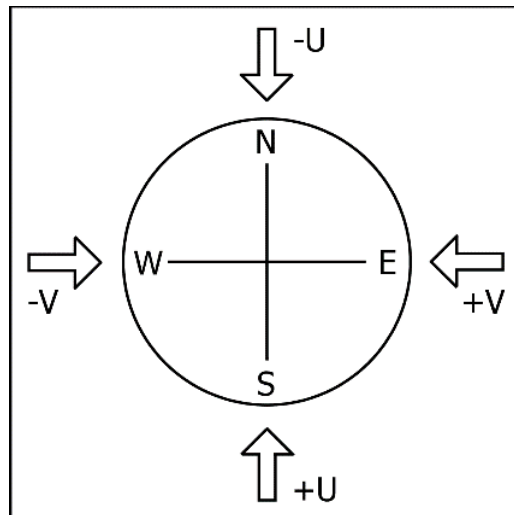
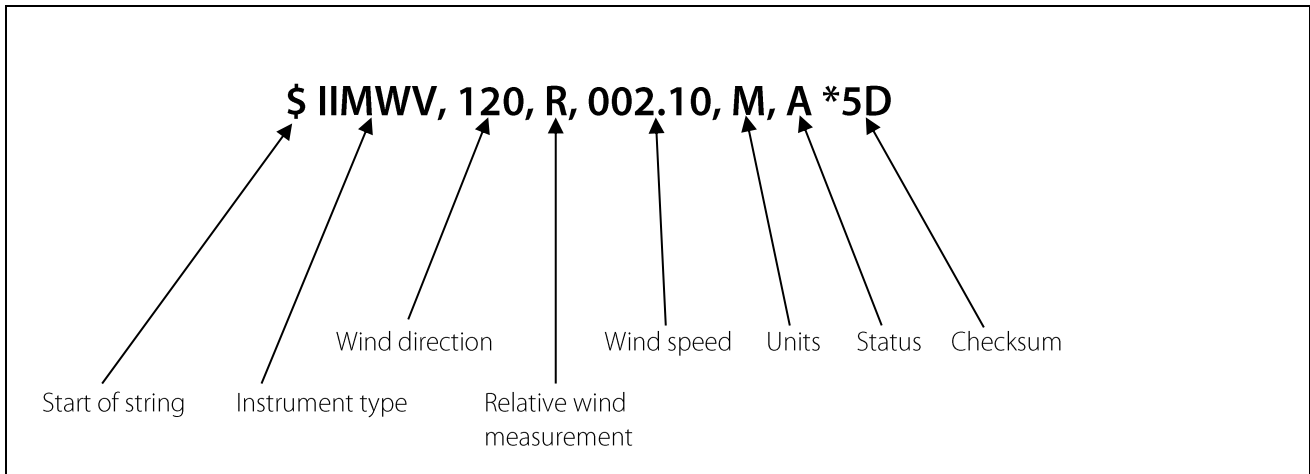

Figure 5 UV Polarity

### 6.3. NMEA Format (NMEA status codes)



The **Wind Direction**, **Wind Speed**, and **Units** are as described in Section 6.1.

The **Instrument Type** – IIMWV - is a mnemonic for Integrated Instrument Mean Wind direction & Velocity (alternative start of string format WIMWV can be selected).

The **Gill Status** codes are as described in Appendix G

A - **A**cceptable measurement

V - **V**oid measurement

A typical WindSonic configuration suitable for NMEA:

M5, U1, O1, L1, P1, B3, H1, NQ, F1, E2, T1, S4, C2, G0, K50

Consult specification NMEA 0183 version 3 (available on the web) for complete interface details.

The WindSonic M can also be set for the alternative start of string NMEA format WIMWV

Mode 14, which is a Mnemonic for:-

Wind Instrument Mean Wind direction and Velocity.

The string format will appear as above but with WIMWV at the start of the string.



6.4. NMEA Format (Gill status codes)

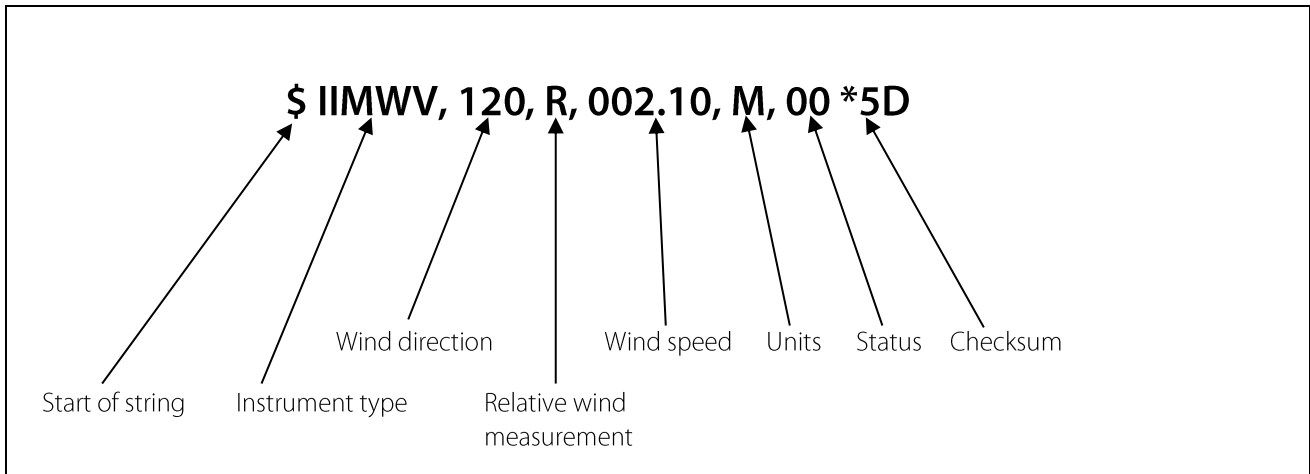

The **Wind Direction**, **Wind Speed**, and **Units** are as described in Section 6.1.

The **Instrument Type** – IIMWV - is a mnemonic for Integrated Instrument Mean Wind direction & Velocity (alternative start of string format WIMWV can be selected).

The **Gill Status** codes are as described in Appendix G

A typical WindSonic configuration suitable for NMEA:

M16, U1, O1, L1, P1, B3, H1, NQ, F1, E2, T1, S4, C2, G0, K50

Consult specification NMEA 0183 version 3 (available on the web) for complete interface details.

### 6.5. Gill format – Tunnel Mode (UU, Continuous)

In this mode, the output is given as a signed figure (i.e. positive or negative) along the 'U' (= South – North) axis.

Direction is indicated by a 0 or 1.

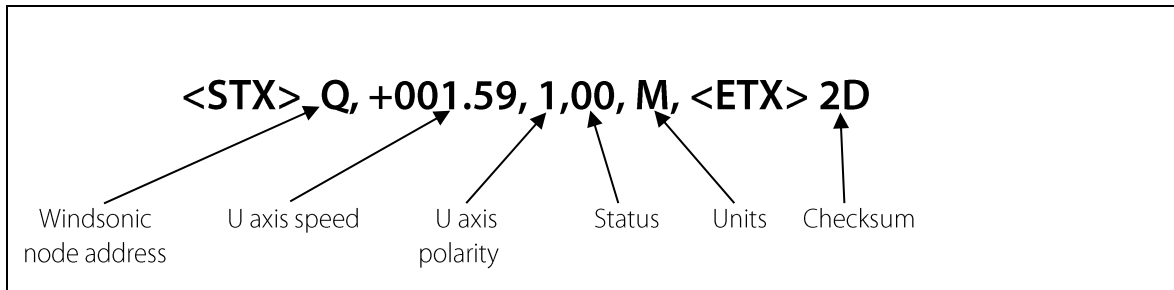

Where:

- <STX> = Start of string character (ASCII value 2)
- WindSonic node address = Unit identifier
- U axis = U axis Wind Speed
- U axis = U axis Wind Direction Polarity where: -  
0 (-U vector) is a wind from the North direction or  
1 (+U vector) is a wind from the South direction.

See Section 6.1 for other string information.

### 6.6. Analogue Outputs and Options



**Analogue outputs are not available from the WindSonic M.**

## Appendix A - Technical Specification

| <b>Wind Measurement</b>       |   |
|-------------------------------|---|
| Units of measure              | Metres/second (m/s)<br>Kilometres per hour (kph)<br>Miles per hour (mph)<br>Feet per minute (fpm)<br>Knots            |
| Output Frequency              | 0.25, 0.5, 1, 2, or 4 outputs per second  |
| Digital Output Parameters     | Polar - Speed and Direction<br>UV - 2 axis, signed Speed<br>NMEA Speed and Direction<br>Tunnel - U speed & U Polarity |
| <b>Wind Speed</b>             |   |
| Range                         | 0 – 60m/s,  |
| Accuracy                      | ± 2% (at 12m/s)   |
| Resolution                    | 0.01 m/s  |
| <b>Wind Direction</b>         |   |
| Range                         | 0 - 359°  |
| Accuracy                      | ± 3° (at 12m/s)   |
| Resolution                    | 1°  |
| <b>Digital output formats</b> |   |
| Gill ASCII                    | Continuous or Polled (output on request by host system)<br>Polar (Speed and Direction) or UV (2 axis, signed Speed)   |
| Marine – NMEA                 | NMEA 0183 version 3   |
| Tunnel                        | Tunnel - U speed & U Polarity   |
| <b>Communication Format</b>   |   |
| Data Levels                   | RS232, RS422 and RS485 (2 wire Point to Point only)   |
| Baud Rates                    | 2400, 4800, 9600, 19200, 38400  |
| <b>Anemometer Status</b>      | <b>Status OK and error codes (not for heating) included in output message</b>   |

| <b>Power Requirement</b> |                |   |
|--------------------------|----------------|---|
| Sensor Power             | Sensor Power   | 5V to 30 V dc.  |
|                          | Sensor Current | 9mA @ 12V DC (1Hz, 9600B, RS232).                               |
|                          | Sensor Current | 5.5mA @ 12V DC (0.25Hz, 9600B, RS232).                          |
| Heater Power             | Heater Power   | 10V to 30.0V DC.  |
|                          | Heater Power   | 24V rms AC ± 10 % @50/60Hz.                                     |
|                          | Heater Current | Allow for 2.2 Amps @ 12V DC nominal supply<br>(26W max.).       |
|                          | Heater Current | Allow for 4.2 Amps @24v AC or DC nominal Supply<br>(100W max.). |

| <b>Mechanical MetConnect Range</b> |   |
|------------------------------------|---|
| External Construction              | External - Aluminium Alloy 6061 T6 or T4, hard anodise finish.<br>Connector - Polycarbonate blend |
| Mounting                           | Pipe mounting 1.75 inches (44.45mm) diameter  |
| Weight                             | 0.9kg   |
| Size                               | 142mm diameter x 163mm  |

| <b>Environmental</b>  |   |
|-----------------------|---|
| Moisture protection   | IP66  |
| Operating Temperature | Operating -35°C to +70°C Unit without Heating.<br>Operating -40°C to +70°C Unit with Heating. |
| Storage Temperature   | Storage -40°C to +80°C  |
| Humidity              | Operating <5% to 100%   |
| Hail                  | UL2218 Class 1  |
| EMC                   | EN 61326:1998 and BSEN 60945<br>FCC CFR47 Parts 15.109 Class A                                |
| <b>Standards</b>      | Manufactured within ISO9001: 2015 quality system  |

| <b>Software</b> |   |
|-----------------|---|
| Wind            | Free PC Software to set-up Windsonic M            |
| Windview        | Free PC Software to view and log Windsonic M data |

## Appendix B - Cable Assembly

### Preparation.

Open the pack of parts provided with the WindSonic M or as part 1405-PK-069.

Note that the connector supplies the correct strain relief for cables with an outside diameter of 6-12mm.

Trim back the screened cable outer and screen sleeves 40mm.

Trim back the screen drain wires flush with the outer sleeve.

Strip back the connection wires by 5mm.

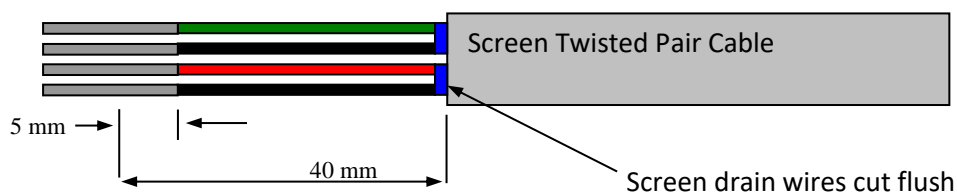

### Soldering Contacts.

Note that the supplied size 20 contacts are suitable for wire gauges 20 AWG to 24 AWG.

Tin solder the stripped wires.

Solder the contact pins to the wires.

### Crimping Contacts.

Note that the supplied size 20 contacts are suitable for wire gauges 20 AWG to 24 AWG.

Example crimp tools are:-

Daniels Manufacturing Corporation Tool AF8 and Turret TH1A.

[https://www.dmctools.com/oscar/catalogue/af8\\_271/](https://www.dmctools.com/oscar/catalogue/af8_271/)

[https://www.dmctools.com/oscar/catalogue/th1a\\_3128/](https://www.dmctools.com/oscar/catalogue/th1a_3128/)

or

Astro Tool Corporation Crimp tool 615708 and Turret 615709.

<https://www.astrotool.com/products/615708-m22520-1-01-crimping-tool-dmc-af8/>

<https://www.astrotool.com/products/615709-m22520-1-02-turret-head-dmc-th1a/>



Lightly twist the stripped wires (do not solder the wires).

Insert the wire into the supplied contact barrel and ensure that it can be seen through the contact inspection hole.

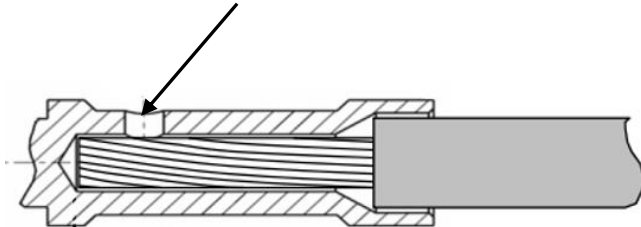

With the crimp tool fully open place the contact and wire into the crimp tool barrel.

Fully close the crimp tool allowing it to re-open on its own.

Visibly check that the wire is visible through the inspection hole.

**Connector Assembly.**



**To disassemble the connector, reverse this procedure**

Put the parts on the cable in the order as shown below.



Whilst squeezing the red retainer in the direction of ARROWS A, pull in the direction of ARROW B

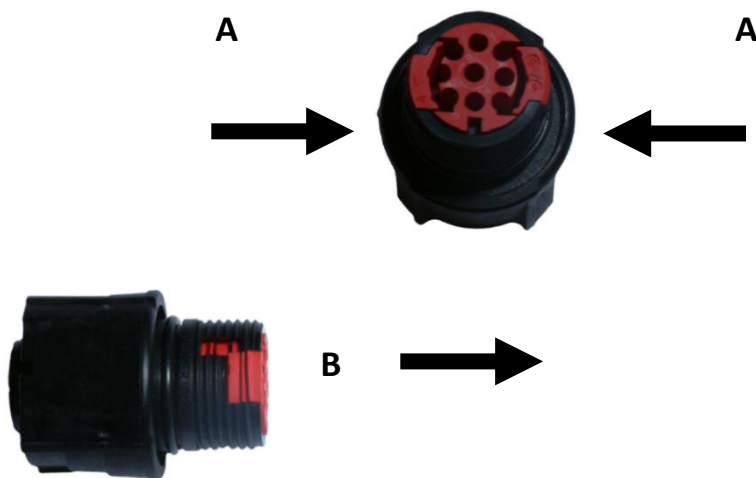

Your connector should now resemble the connector in the picture below.



Insert each contact pin until you feel a slight click. If you have inserted the contact into the incorrect hole it can be removed at this point by simply pulling it out. Please note there will be some resistance.

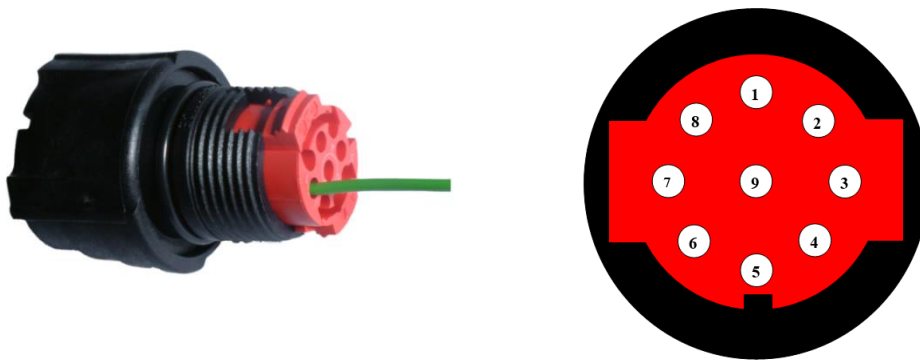

Rear View of Connector

Continue to insert all of the contacts you require. Once all of the contacts are inserted push the red retainer into place. NB. The retainer can only be pushed back into place if the contacts are fully engaged.



Fit the connector to the WindSonic M so that you can finish assembling the connector.



Screw the back shell onto the connector until it is fully in place. Please note that the final rotations can be slightly stiff.



Now screw the next part of the connector into place.



Now screw the cable-clamping nut into place.



The connector can now be removed from the WindSonic M.

### Connector Spares

For spares purposes the complete WindSonic M Souriau Clipper connector comprises of:-

- |                             |   |
|-----------------------------|---|
| 9-way Connector             | CL1F1201.   |
| Connector female contact    | CM10SC10MQ (size 20 contact).                         |
| Sealing Gland Clipper size1 | CL101021 (suitable for cables 6-12mm outer diameter). |



## Appendix C - Windsonic Safe mode

Changing a Default Set WindSonic M RS232 Output (Mode E3) to RS422 Output (Mode, E2).

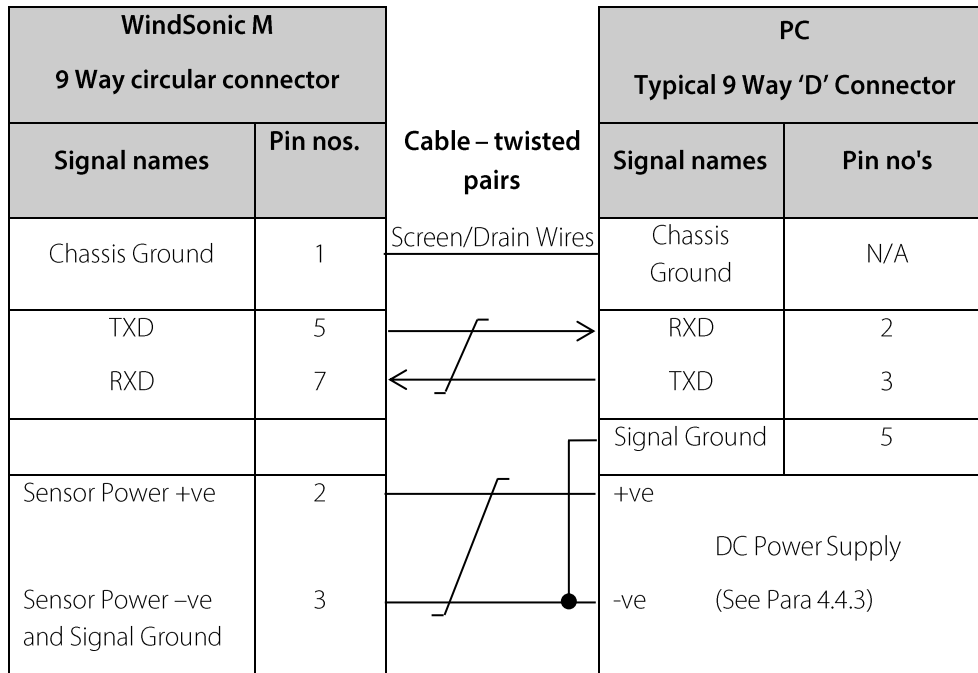

Connect the WindSonic M as per the above diagram.



**Wiring connections below are not the same as a standard WindSonic Option 1 RS232 unit.**

**With WindSonic M power off**, set up a Terminal connection as per page 42 (Configuring using Terminal package) **but with the Baud rate set to 19200** (this can be at variance with the original WindSonic M Baud rate setting).

**Hold down** the \* character (shift 8) and then apply power to the WindSonic M.  
After approximately 3 seconds the unit will respond with **Safe Mode**.

Remove any \* characters on screen or press Enter.

Type E2 and press Enter (changes E3 setting to E2 (RS422)).

E2 will be seen twice on screen to confirm the setting change to RS422 has occurred.

It is possible to make other configuration setting changes now if required.

Type Q and press Enter to go back into measurement mode.

Now wire the WindSonic M to an RS422 device.

If a new terminal connection is required, the Baud rate setting will be as per the WindSonic M configuration setting.

### Using Safe mode to Change an RS422 set Sensor back to RS232 Operation

Connect the WindSonic M as per the diagram on page 33.

(Changing a Default Set WindSonic M RS232 Output (Mode E3) to RS422 Output (Mode, E2)

With WindSonic power off, set up a Terminal connection **but with the Baud rate set to 19200 (this can be at variance with the original WindSonic Baud rate setting).**

**Hold down** the \* character (shift 8) and apply power to the WindSonic. After approximately 3 seconds the unit will respond with **Safe Mode**.

Remove any \* characters on screen or press the Enter key.

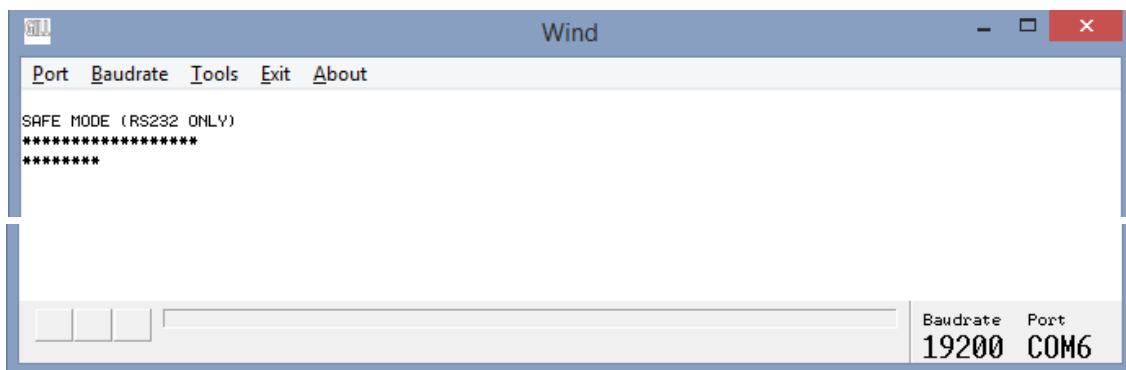

**To check the current configuration settings** Type D3 and press the Enter key.

To change any setting type in the appropriate command and then press the Enter key.

Type Q and press Enter to return to Measurement mode.

Turn off/on the unit to return to normal operation, note that comms may now be lost with the safe mode connection.

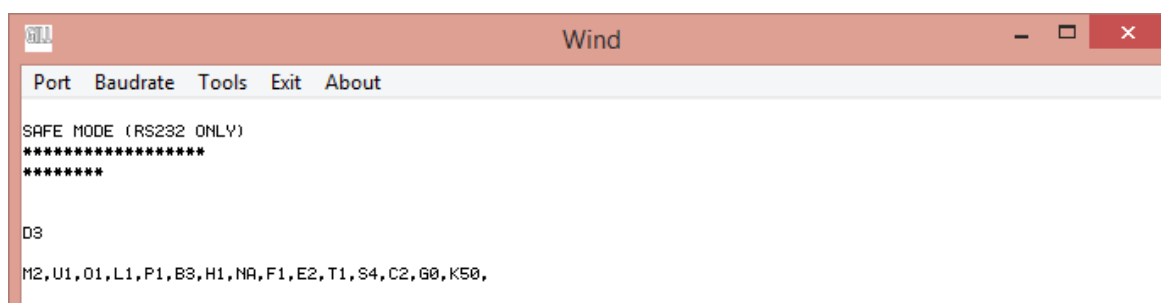

**To Change the Communication setting** from a unit set for RS422 to RS232 when in safe mode:-

Type E3 and press the Enter key.

If the change is successful, then another E3 will be shown.

Type D3 and press Enter to confirm if required.

Turn off/on the unit to return to normal operation, change the Wind Software baud rate setting to match that of the WindSonic to view data.



**Safe Mode above can be used with any WindSonic M for which communication format or configuration settings are not known to obtain communication and change settings.**

## Appendix D – Configuring

Wind may be used to configure the WindSonic M; alternatively, the user may elect to use another terminal emulator package such as Windows HyperTerminal. This section describes the commands used to change User and Communications settings.

### Wind Software

Wind software is available to download, free of charge, from the Gill Instruments Limited website <http://gillinstruments.com/main/software.html>.

Wind software allows the unit configuration to be changed and to be able to display the Digital Data String on a PC screen.



Connect both WindSonic M transmit and receive data lines to the PC to establish 2-way communications.

Open Wind Software and select the appropriate Com Port from the drop-down menu and click on OK to reach the data screen.



If data is not correctly displayed, then on the Menu click on Tools/Synch Comms.

The Sensor will be interrogated, and Sensor Baud Rate and Mode settings detected and reported.

Wind software settings will be adjusted to match those of the sensor to show data scrolling on screen.

If after Synch Comms there is still a problem, repeat Synch Comms or switch off the sensor and switch back on again and repeat above procedure.



**It is also possible to use Wind as a Terminal Program and change settings using the Configuration Mode of operation (Commands are listed on pages 44-50)**

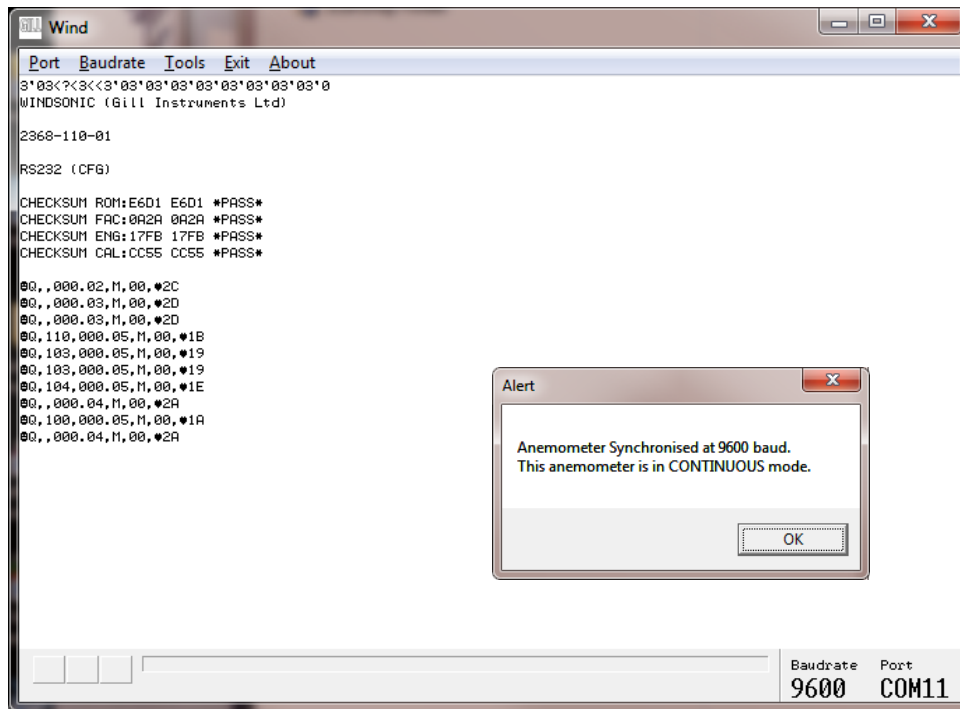

If you wish to review the Sensor Settings, click on **Tools/Report Config**.  
 When selected a similar message to that below will be seen.

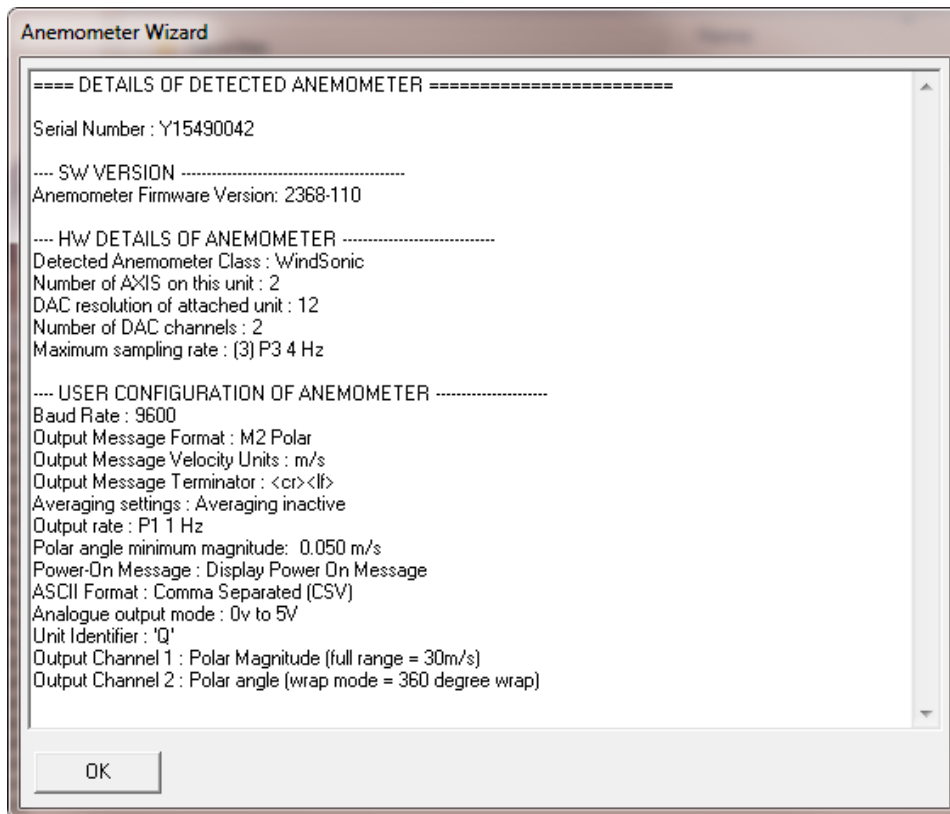

To review and change the WindSonic configuration click on **Tools/Wizard**

Typical Screen is shown following: -

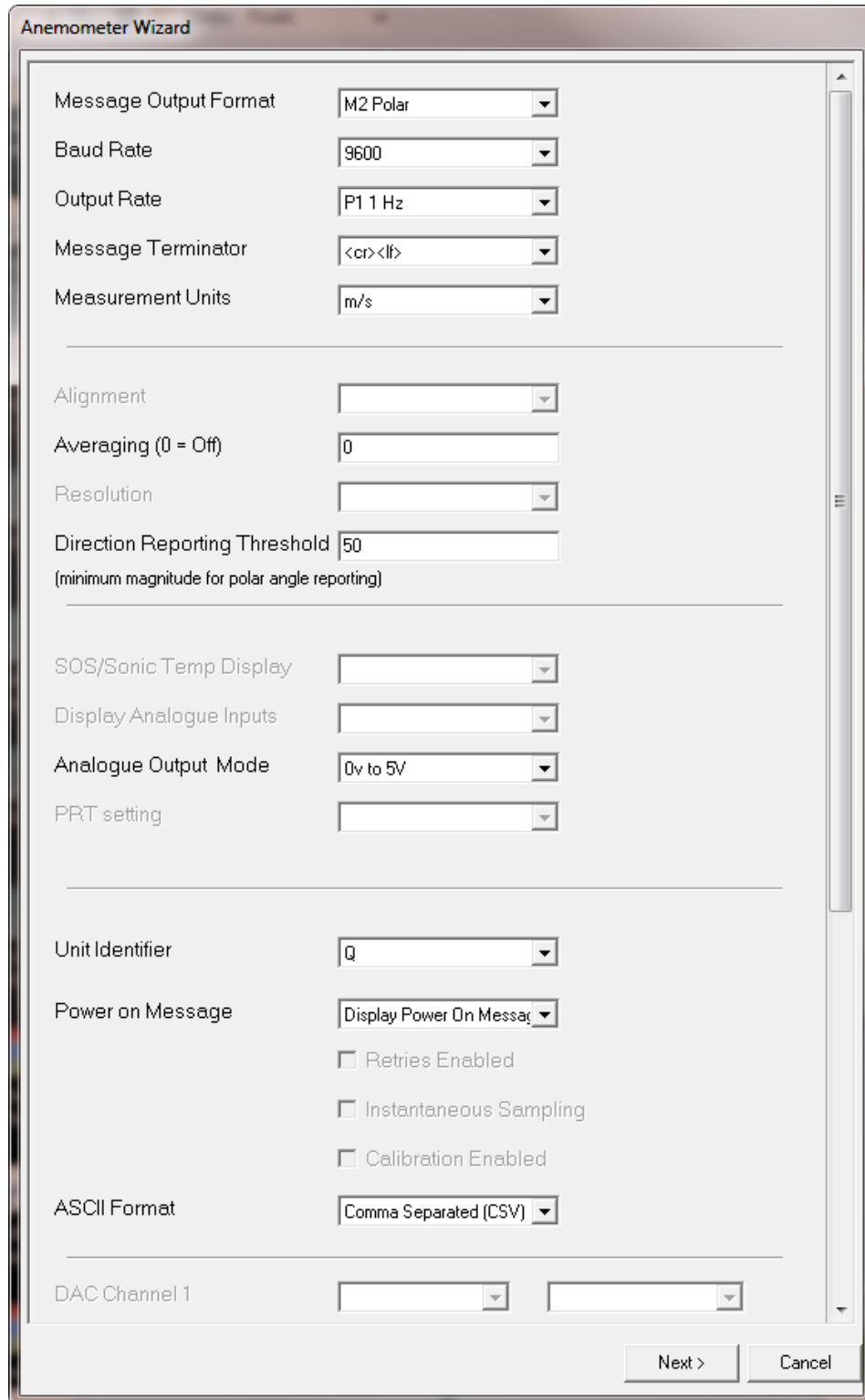

To change a setting i.e. change from M2 (Polar) to M1 (UV), select M1 from the Wizard drop down list then click on Next.

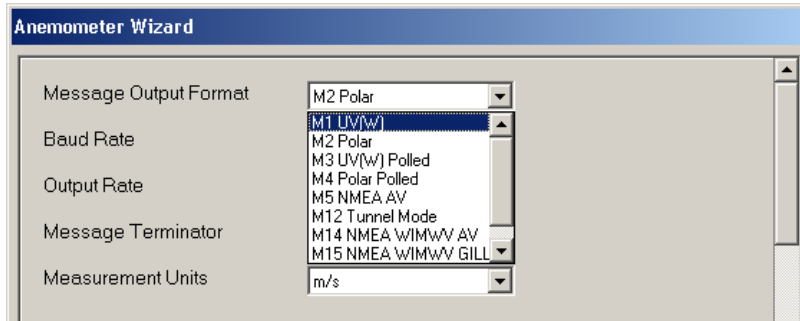

The following screen will show settings that will be changed. Then click on Next.

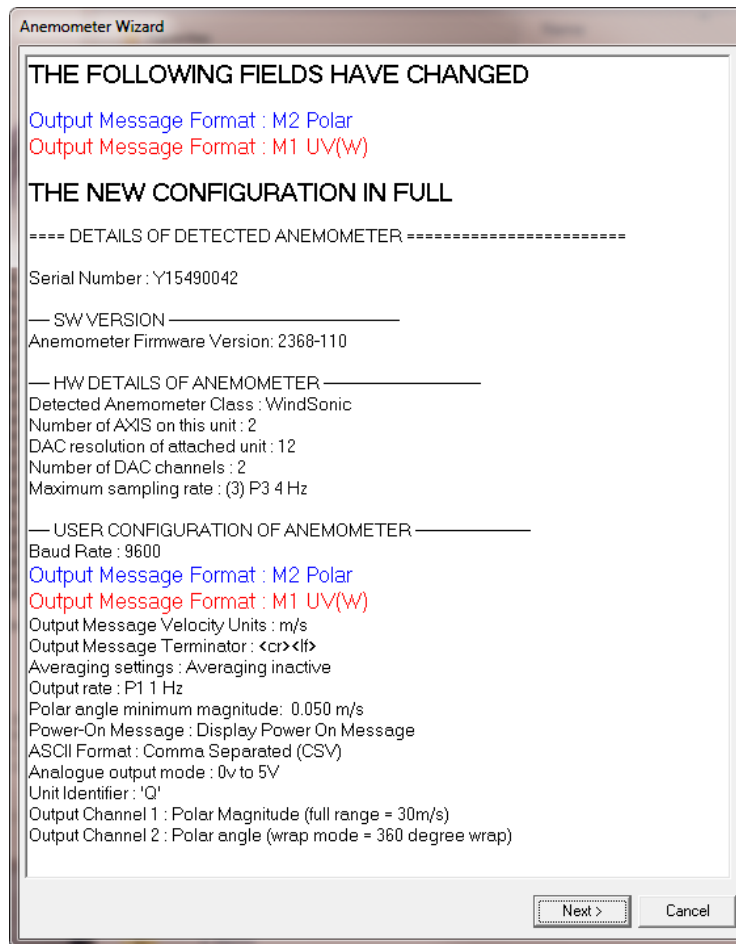

Wind will report Setting up Anemometer and then re-start the anemometer scrolling data in UV mode.

## Configuring using Terminal Program



1. Determine the COM port the WindSonic M is connected to.
2. Run the terminal program (Tera Term, puTTY. Or alternative).
3. Create a New Connection (File → New Connection)
4. Select correct serial port.
5. Change '**Serial port settings**' (Setup → Serial Port)
6. Adjust the Port settings to match WindSonic settings. WindSonic default settings are :

**Bits per second** 9600

**Data bits** 8

**Parity** None

**Stop bits** 1

**Flow Control** (Handshaking) None

Click on OK and data similar to the following example will scroll on screen at the output rate:

☺ Q, 229, 002.74, M, 00, ♥ 06



Other terminal emulators are configured in a very similar way.

## Entering Configuration mode

### From Continuous mode

Type **\***

### From Polled mode

Type **\*** then **<N>**

Where <N> is the Unit identifier

The WindSonic M responds with a CONFIGURATION MODE message, stops reporting wind measurements, and waits for a command (as detailed below).

## Returning to Measurement mode

Type **Q** then press **ENTER**

The WindSonic M responds with a checksum test and then continuous wind information when in continuous mode, or on receipt of a Poll signal when in Polled mode.



## Checking the Configuration

We recommend that, as a standard procedure, you use this command prior to, and after, changing any settings. It shows the current settings for all the alterable settings.

Type **\***

Type **D 3** then press **ENTER**

The WindSonic M responds with the default settings shown below.

**M2, U1, O1, L1, P1, B3, H1, NQ, F1, E3, T1, S4, C2, G0, K50**

We suggest you note down the settings, so that you can easily return to them.

To return to measurement mode:-

Type **Q** then press **ENTER**

All of the above settings are explained in the following sections.

## Changing a setting

To change a setting, refer to the sections below, enter the command of the new setting required, followed by **ENTER**. The new setting will be sent as a message by the WindSonic M.

For example, to change the message format to NMEA, Type **M 5** and press **ENTER**

The WindSonic M will reply **M5**. When the unit is returned to the Measurement mode, it will be in NMEA format.



The factory-set (default) settings are shown in **bold** in the following sections.

To Change E Command setting refer to **Safe Mode** operation, Appendix C.

### Command List

| COMMAND | USER                         |
|---------|------------------------------|
| B       | Baud rate                    |
| C       | Analogue angle wrapping      |
| D       | Diagnostic and Configuration |
| E       | Set Physical Comms           |
| F       | Data and Parity Options      |
| G       | Not currently used           |
| H       | Power-Up message             |
| K       | Minimum Direction Velocity   |
| L       | Message Terminator           |
| M       | Message Format               |
| N       | Unit ID                      |
| O       | ASCII Output format          |
| P       | Output rate                  |
| Q       | MEASUREMENT MODE             |
| S       | Analogue output range        |
| T       | Analogue output type         |
| U       | Select Units                 |
| *       | INTERACTIVE MODE             |

#### Bx – Baud rate

| Item  | Options     | Command   |
|---|-------------|-----------|
| <b>Baud rate</b>  | 2400        | B1        |
|   | 4800        | B2        |
|   | <b>9600</b> | <b>B3</b> |
|   | 19200       | B4        |
|   | 38400       | B5        |
| <p>To change the Baud rate when using a terminal package: -<br/>                     E.g. If set to B3 (9600 baud) and it is required to set to Baud rate to B2 (4800 baud).<br/>                     Type * to enter Configuration Mode.<br/>                     Type B 2 and press ENTER. (Do not type any further commands at this stage).<br/>                     Change the terminal setting to match the new Baud rate setting (4800).<br/>                     Type B and press ENTER, the letter B will be shown followed by Capitol B2<br/>                     Type Q and press ENTER, data will scroll at the new baud rate.</p> |             |           |

**Cx – Analogue settings**

Not Applicable.

**Dx – Diagnostic and Configuration Command (See command list) page 44**

**Ex – Communications Protocol**

| Item  | Options       | Command   |
|---|---------------|-----------|
| Communications protocol   | RS422 / RS485 | E2        |
|   | RS232         | <b>E3</b> |
| To change settings refer to Connecting to a PC. See section 4.6 |               |           |

**Fx – Data and parity options**

| Item                    | Options             | Command   |
|-------------------------|---------------------|-----------|
| Data and parity options | 8 bits, no parity   | <b>F1</b> |
|                         | 8 bits, even parity | F2        |
|                         | 8 bits, odd parity  | F3        |

**Gx – (To be allocated for future developments)**

### Hx – Power-up Message

| Item   | Options   | Command  |
|--|-----------|----------|
| Power –up message  | ON<br>OFF | H1<br>H2 |
| <p>If the power up message is On, then a message similar to that below is output, whenever the unit goes into Measurement mode (i.e. when power is first applied to the unit, or unit returns to Measurement mode from Configuration mode).</p> <p>WINDSONIC (Gill Instruments Ltd)<br/>2368-110-01<br/>RS485/RS422 (CFG)<br/>CHECKSUM ROM:E15C E15C *PASS*<br/>CHECKSUM FAC:0A42 0A42 *PASS*<br/>CHECKSUM ENG:12BE 12BE *PASS*<br/>CHECKSUM CAL:C980 C980 *PASS*</p> <p>If any of these checksums fail, the word PASS will be replaced by FAIL and the unit will use its default settings. If the checksum repeatedly fails after power on – contact your supplier.</p> |           |          |
| <p> The exact message above may vary.</p>   |           |          |

### Kxx to Kxxxx – Minimum Direction Velocity

| Item  | Options         | Command             |
|---|-----------------|---------------------|
| Minimum Direction Velocity  | 0.05m/s to 5m/s | K50<br>KXX to KXXXX |
| <p>This feature allows the minimum wind velocity to be set at which display of the direction is enabled in thousandth of a metre per second. The default is 50, which means that any wind magnitude less than 0.05m/s will have the wind direction omitted in Comma Separated Variable mode.</p> <p>E.g. Q,,000.04,M,3C.<br/>Or last wind reading at 0.05m/s or above repeated in Fixed Field Mode.<br/>E.g. Q,237,000.04,M,3C.</p> |                 |                     |

### Lx – Message Terminator

| Item               | Options   | Command |
|--------------------|-----------|---------|
| Message terminator | <CR> <LF> | L1      |
|                    | <CR>      | L2      |

### Mx to Mxx – Message Format

|                |   |            |
|----------------|---|------------|
| Message Format | Gill, UV, Continuous  | M1         |
|                | <b>Gill, Polar, Continuous</b>                                | <b>M2</b>  |
|                | Gill, UV, Polled  | M3         |
|                | Gill, Polar, Polled   | M4         |
|                | NMEA, IIMWV (NMEA status code)                                | M5         |
|                | Tunnel Continuous   | M12        |
|                | NMEA, WIMWV (NMEA status code)                                | M14        |
|                | NMEA, WIMWV (Gill status code) NMEA, IIMWV (Gill status code) | M15<br>M16 |

### Nx – Node Address

|              |               |      |
|--------------|---------------|------|
| Node Address | Q...-(A to Z) | N<Q> |
|--------------|---------------|------|

If used in polled mode then it is recommended that ID's A to F and K, M, N and P are not used, as these characters can be present in the data string.

## Ox – ASCII Output Format

| Item                | Options                      | Command |
|---------------------|------------------------------|---------|
| ASCII output format | Comma separated format (CSV) | O1      |
|                     | Fixed field                  | O2      |

Example data string for CSV data changing to low wind less than 0.05m/s (set for K50) and error status code condition.

Q,156,000.05,M,00,19

Q,,000.04,M,00,2A (low wind, no direction figure output at 0.04m/s or lower).

Q,100,000.09,M,00,16

Q,,,M,0424 (error data, no figures output in wind fields).

Example data string for Fixed Field data changing to low wind less than 0.05m/s (set for K50) and error status code condition.

Q,160,000.05,M,00,1C

Q,160,000.04,M,00,1D (low wind, last direction figure at 0.05m/s or above retained).

Q,170,000.06,M,00,1E

Q,999,999.99,M,04,0A (error data, wind fields padded with 9's).

## Px to Pxx – Output Rate

| Item        | Options                   | Command |
|-------------|---------------------------|---------|
| Output rate | 1 per second              | P1      |
|             | 2 per second              | P2      |
|             | 4 per second              | P3      |
|             | 1 reading every 4 seconds | P20     |
|             | 1 reading every 2 seconds | P21     |
|             |                           |         |

**Q – Measurement Mode**

Refer to Appendix D p42 (Returning to Measurement mode)

**Sx - Settings**

Not Applicable.

**Tx – Settings**

Not Applicable.

**Ux – Output Units**

| Item                    | Options                      | Command   |
|-------------------------|------------------------------|-----------|
| <b>Output<br/>Units</b> | <b>Metres per second (M)</b> | <b>U1</b> |
|                         | Knots (N)                    | U2        |
|                         | Miles per hour (P)           | U3        |
|                         | Kilometres per hour (K)      | U4        |
|                         | Feet per minute (F)          | U5        |

## Configuration / Diagnostic Information

Each of these commands causes a response from the WindSonic M.

| Item                   | Command | Response  |
|------------------------|---------|---|
| Type and serial No.    | D1      | Y16120001   |
| Software version       | D2      | 2368-110-01   |
| Unit configuration     | D3      | M2,U1,O1,L1,P1,B3,H1,NQ,F1,E3,T1,S4,C2,G0,K50,  |
| Supply Voltage         | D5      | +11.7v  |
| Self-test              | D6      | <p><i>See Appendix H</i></p> ALIGNMENT LIMITS:0D59,0CF5<br>ALIGNMENT U:OD15 *PASS*<br>ALIGNMENT V:OD16 *PASS*<br>CHECKSUM ROM:AB7D AB7D *PASS*<br>CHECKSUM FAC:04F4 04F4 *PASS*<br>CHECKSUM ENG:082A 082A *PASS*<br>CHECKSUM CAL:A9C1 A9C1 *PASS*   |
| Hardware Configuration | D10     | Serial Number : Y16120001<br>Software Version : 2368-110-01<br><br>Class : WINDSONIC (Gill Instruments Ltd)<br><br>Number of axes on this unit : 2<br>Axes tilted 45deg to horizontal plane<br>No Analogue Outputs<br>Maximum output rate: 004Hz<br>Maximum base rate on this unit is 16Hz sampling<br>Available baudrates: 002400 004800 009600 019200 038400<br>Available messages: M1 M2 M3 M4 M5 M12 M14 M15 M16<br>Safe mode enabled<br>Parity control allowed: F1 F2 F3<br>Communication modes: RS232 RS485/422 |



## Appendix E – Polled Mode Commands

### Gill format – Polled (Polar or UV)

When in the Polled mode, an output is only generated when the host system sends a Poll signal to the WindSonic M consisting of the WindSonic M Unit Identifier – that is, the relevant letter A – Z.

The output formats are otherwise as described in Sections 6.1 and 6.2.

The commands available in this mode are:

| Description                         | Command   | WindSonic M response        |
|-------------------------------------|-----------|-----------------------------|
| WindSonic M Unit Identifier         | A ..... Z | Wind speed output generated |
| Enable Polled mode                  | ?         | (None)                      |
| Disable Polled mode                 | !         | (None)                      |
| Request WindSonic M Unit Identifier | ? &       | A ..... Z (as configured)   |
| Enter Configuration mode            | ? * <N>   | CONFIGURATION MODE          |

Where <N> is the unit identifier, it is recommended that ID's A to F and K,M,N, or P are not used as these characters can be present in the data string.

Notes: -

It is suggested that in polled mode the following sequence is used for every poll for information.

? Ensures that the Sensor is enabled to cover the event that a power down has occurred.

A-Z Appropriate unit designator sent to retrieve a line of data.

! Sent to disable poll mode and reduce possibility of erroneous poll generation.

When in polled mode the system will respond to the data command within 130mS with the last valid data sample as calculated by the Output rate (P Mode Setting).

If the unit is powered down after use or upon switch on then allow 5 seconds from switch on before sending poll commands.

Polled mode can only be used for point to point communications, it is not possible to network units on a common bus.

## Appendix F - Wind View Software

Gill WindView software is available to download, free of charge from the Gill Instruments Limited website <http://gillinstruments.com/main/software.html>

WindView features include: -

- Data Display
- Data Logging



***WindView cannot be used to change the WindSonic M configuration.***

Open Gill WindView software program.

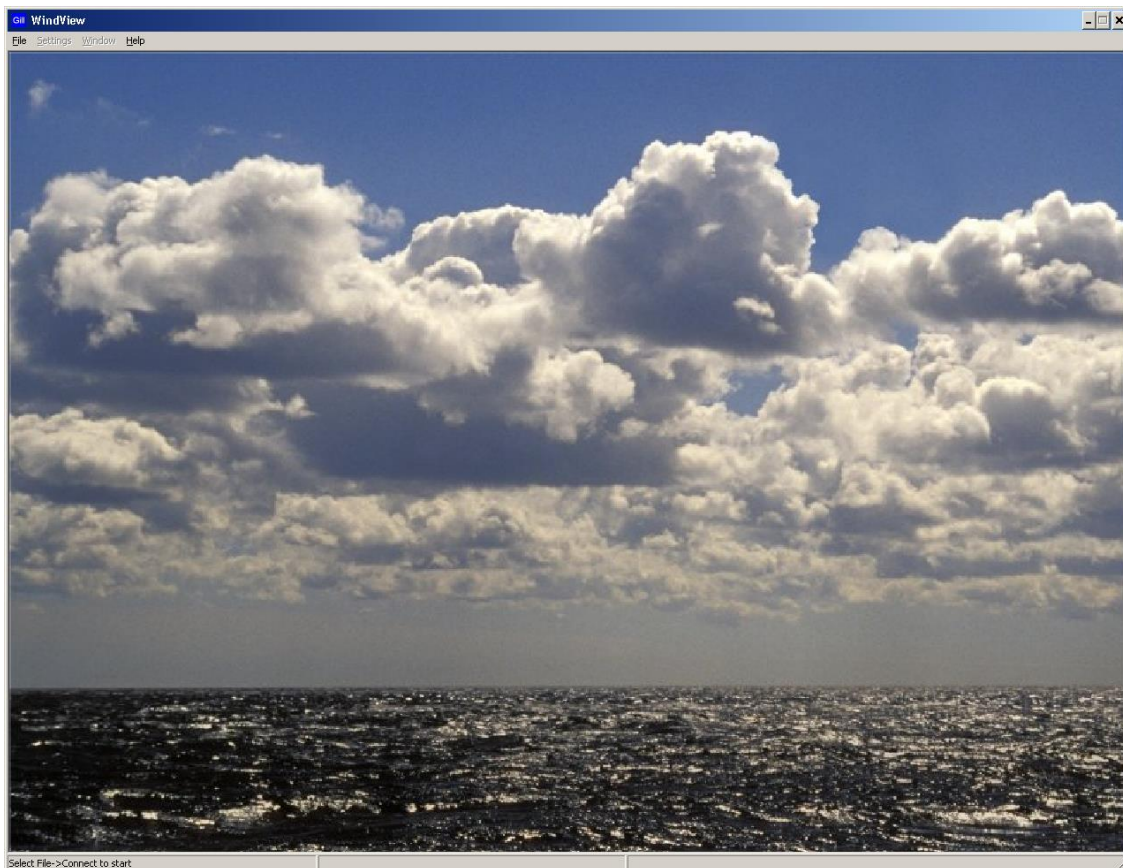



Select File/Connect as follows:-

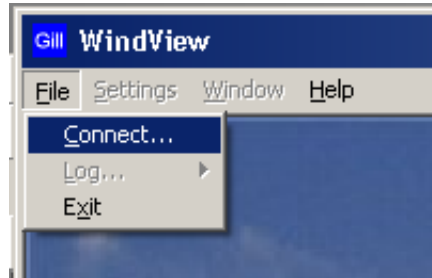

Select the required COM Port from the drop down list.  
Select the required Baud rate from the drop down list.  
Parity should be set to none.

If the Baud rate setting of the Anemometer is unknown, then the Auto Find button can be used to interrogate the Anemometer and detect the required setting.

Click on the Connect button.

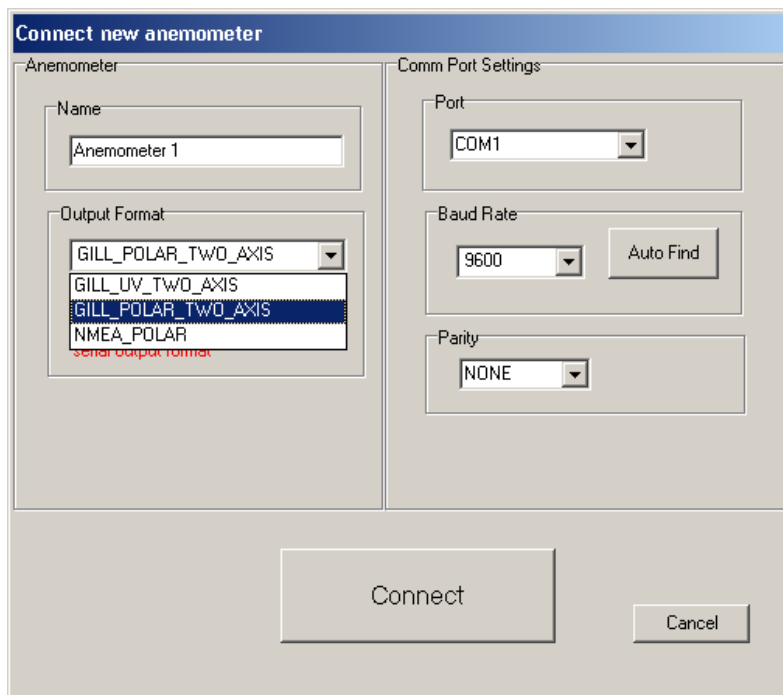

Data should scroll on the screen as follows (Data button).

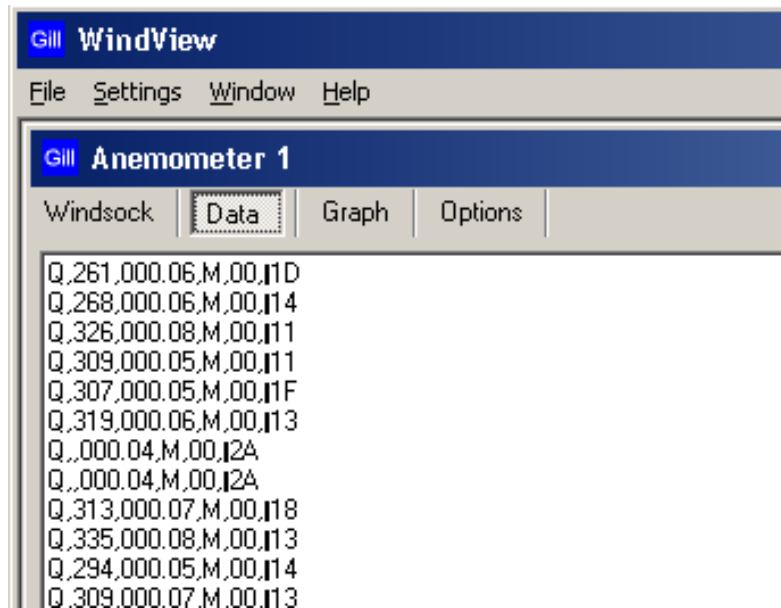

Clicking on the Anemometer 1 Windsock button gives the following display.

To Change WindView Display Settings

Click on the top of Screen menu Settings.

To change displayed units select and click on required measurement units. If for instance the sensor data was outputting metres per second data then WindView performs the calculation to convert and display the output in knots/mph/kph etc.

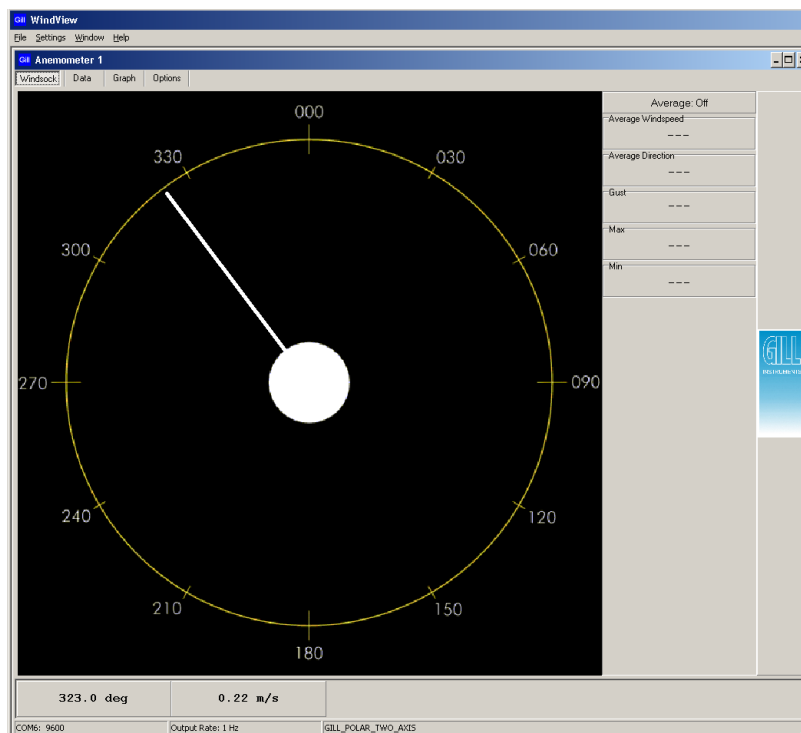

For Logging Facilities.

Click on Settings/Logging to reach the logging screen.

If segmented logging is required this will create and save individual files of length set by the figure in the mins box.

Otherwise a continuous log file will be recorded.

Select required Directory for saved file and File name.

Click on Apply.

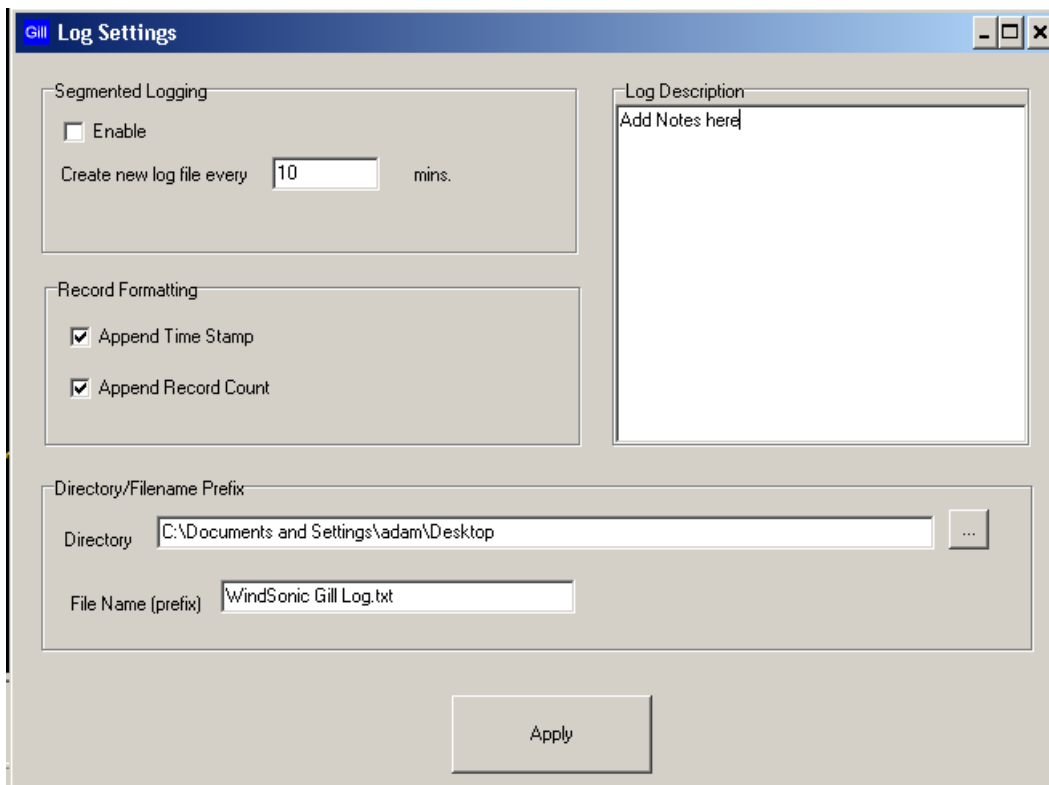

Click on the Note OK button.

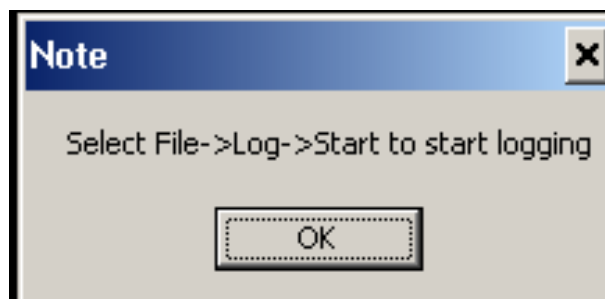

To Start Logging select File/Log/Start.

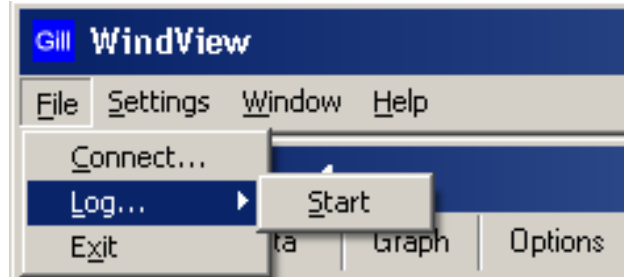

To stop logging select File/Log/Stop.

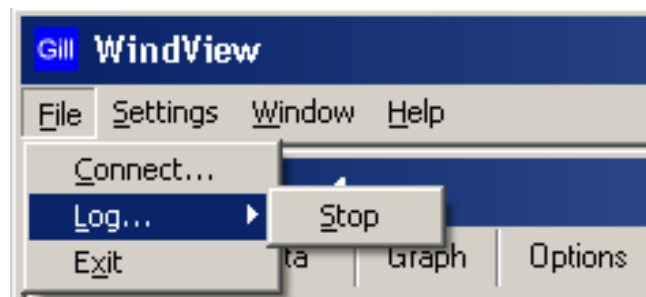

Example saved data opened in Notepad.

```

File Edit Format View Help
WindView Log File
Add Notes here
windsonic log test
Name: Anemometer 1
Output Format: GILL_POLAR_TWO_AXIS
Log file opened: 13/06/2008 10:50:09

Q,322,000.22,M,00,01D,1,13/06/2008 10:50:10
Q,307,000.22,M,00,01A,2,13/06/2008 10:50:11
Q,342,000.28,M,00,011,3,13/06/2008 10:50:12
Q,320,000.29,M,00,014,4,13/06/2008 10:50:13
Q,340,000.12,M,00,01A,5,13/06/2008 10:50:14
Q,312,000.21,M,00,01D,6,13/06/2008 10:50:15
Q,318,000.37,M,00,010,7,13/06/2008 10:50:16
Q,321,000.26,M,00,01A,8,13/06/2008 10:50:17
Q,291,000.19,M,00,01C,9,13/06/2008 10:50:18
Q,312,000.14,M,00,01B,10,13/06/2008 10:50:19
Q,314,000.20,M,00,01A,11,13/06/2008 10:50:20
    
```

## Appendix G - Status Codes

The Status code is sent as part of each wind measurement message.

| Code      | Status              | Condition   |
|-----------|---------------------|---|
| <b>00</b> | <b>OK</b>           | <b>Sufficient samples in average period</b>         |
| 01        | Axis 1 failed       | Insufficient samples in average period on U axis    |
| 02        | Axis 2 failed       | Insufficient samples in average period on V axis    |
| 04        | Axis 1 and 2 failed | Insufficient samples in average period on both axes |
| 08        | NVM error           | NVM checksum failed                                 |
| 09        | ROM error           | ROM checksum failed                                 |
| A         | -                   | NMEA data Acceptable                                |
| V         | -                   | NMEA data Void                                      |

## Appendix H - Maintenance & Fault-Finding

### Cleaning

If there is any build-up of deposit on the unit, it should be gently cleaned with a cloth moistened with soft detergent. Solvents should not be used, and care should be taken to avoid scratching any surfaces. The unit must be allowed to defrost naturally after being exposed to snow or icy conditions, do NOT attempt to remove ice or snow with a tool.



**Do NOT remove black “rubber” transducer caps.**

### Servicing

There are no moving parts or user-serviceable parts requiring routine maintenance.

Opening the unit or breaking the security seal will void the warranty and the calibration.

In the event of failure, prior to returning the unit to your authorised Gill distributor, it is recommended that:

1. All cables and connectors are checked for continuity, bad contacts, corrosion etc.
2. A bench test is carried out as described on page 57 (Bench Test)
3. You contact your supplier for advice

### Fault Finding

| Symptom  | Solution   |
|--|--|
| No output  | <p>Check DC power to WindSonic M, cable and connections.</p> <p>Check comms settings of WindSonic M and host system match, including correct Com port</p> <p>Check unit is in Continuous mode</p> <p>Check that in-line communication devices are wired correctly.</p> <p> It is usual for Anemometer TX + to be connected to converter device RX +</p> |
| Corrupted output   | <p>Check comms settings of WindSonic and host system match.</p> <p>Try a slower baud rate.</p> <p>Check cable lengths and type of cable.</p>   |
| One way communication                                    | <p>Check WindSonic and host system are both set to the same protocol RS232, RS422, or RS485.</p> <p>Check wiring is in accordance with the manual.</p>   |
| Failed / Incorrect WindSonic M output, data invalid flag | <p>Check that transducer path is not blocked</p>   |



## Returning Unit

If the unit has to be returned, it should be carefully packed in the original packaging and returned to your authorised Gill distributor, with a full description of the fault condition.

## Bench Test

### **Data Tests**

1. Couple the WindSonic M to the host system and power supply, using a known working test cable.
2. Check that the unit is correctly configured by going into Configuration mode and using D3  
*Appendix D (Error! Reference source not found.)*
3. Check for normal output data, and that the Status Code is OK – 00 (or A for NMEA format).
4. If the status code is other than 00 or A, refer to Appendix G Status (error) codes.
5. Use an office fan or similar to check that the unit is sensing wind, turning the unit to simulate changing wind direction and to check that both axes are functioning.
6. Note that this is a quick functional test. There are no calibration adjustments; the unit is designed NOT to require re-calibration within its lifetime.

### **Heater Tests (if applicable)**

1. Connect the WindSonic M Heater wires to a 24v dc power supply.
2. Switch on the heater Power Supply and observe that heater current is drawn and is greater than 2.5 amps.
3. Heating current will be taken for approximately 60 seconds, check that the underneath of the top reflector plate has warmed up and the top of the transducer mounting assembly has warmed up.

## Self – Test (Still Air)

This test checks Alignment and Checksums.

**Alignment tests:** The unit performs a transducer geometry check and compares the result with its factory setting.

**Checksum tests:** The unit performs a check of its program and data memory.



**This test should only be carried out under still air conditions and at room temperature (17-23°C).**



1. Use the original packing box (inner and outer) to enclose the unit. (The packaging is designed as a zero wind enclosure).

2. Go into Configuration Mode  .

3. Carry out the Self-test by entering   .

A message similar to that shown below will be generated:

```
ALIGNMENT LIMITS:0D59,0CF5
ALIGNMENT U:OD15 *PASS*
ALIGNMENT V:OD16 *PASS*
CHECKSUM ROM:AB7D AB7D *PASS*
CHECKSUM FAC:04F4 04F4 *PASS*
CHECKSUM ENG:082A 082A *PASS*
CHECKSUM CAL:A9C1 A9C1 *PASS*
```

For each of the Alignment tests a Pass or Refer to Manual message is generated.

For each of the Checksum tests a Pass or Fail message is generated.

4. If any of the tests fail, contact your supplier.

If a "refer to manual" message appears please *see Appendix H Maintenance & Fault Finding*.



**That it will only pass if the specified temperature and zero wind conditions are met**

Check that there are no visible obstructions or damage to the unit before contacting Gill or your authorised distributor for further advice.

## Calibration

A Custom calibration is available from Gill Instruments. This must be specified at the time of order, or the unit must be returned to Gill Instruments for retrospective calibration.

## Appendix I - Glossary & Abbreviations

| Item                  | Meaning   |
|-----------------------|---|
| CAL                   | Calibration   |
| CR                    | Carriage Return   |
| CSV                   | Comma Separated Variable  |
| ENG                   | Engineering   |
| FAC                   | Factory   |
| KPH                   | Kilometres per Hour   |
| LF                    | Line Feed   |
| MPH                   | Miles per Hour  |
| NMEA 0183 (version 3) | National Marine Electronics Association standard for interfacing marine electronic navigational devices |
| NVM                   | Non-Volatile Memory   |
| PC                    | IBM compatible Personal Computer  |
| ROM                   | Read Only Memory  |
| RS232                 | Communications standard   |
| RS422                 | Communications standard   |
| RS485                 | Communications standard   |
| RXD                   | Received Data   |
| TXD                   | Transmitted Data  |
| WMO                   | World Meteorological Organisation   |

## Appendix J - Guarantee & FCC

### Guarantee

For terms of guarantee contact your supplier or refer to the Gill Instruments Terms & Conditions here:

<https://gill.group/wp-content/uploads/Gill-Group-Company-Terms-Conditions-of-Sale-9170-0003-Issue-02-March-20...pdf>

### FCC

WindSonic complies with part 15 of the FCC Rules. Operation is subject to the following two conditions: -

- (1) This device may not cause harmful interference, and
- (2) This device must accept any interference received, including interference that may cause undesired operation.

This equipment has been tested and found to comply with the limits for a Class A digital device, pursuant to part 15 of the FCC Rules. These limits are designed to provide reasonable protection against harmful interference when the equipment is operated in a commercial environment. This equipment generates, uses, and can radiate radio frequency energy and, if not installed and used in accordance with the instruction manual, may cause harmful interference to radio communications. Operation of this equipment in a residential area is likely to cause harmful interference in which case the user will be required to correct the interference at his own expense.

**As a representative of this supplier, we – from Observator – distribute these products. Originating from the Netherlands, Observator has grown into an internationally oriented company with a worldwide distribution network.**

**For more information contact Observator Instruments:**

**Australia**

T: +61 3 8706 5000

E: sales.au@observator.com / service.au@observator.com

**Germany**

T: +49 (0)152 02047306 / +49 (0)152 02047308

E: contact@observator.com

**The Netherlands**

T: +31 (0)180 463411

E: sales@observator.com / service@observator.com

**Poland**

T: +48 537 209 665

E: a.miller@observator.com

**Singapore**

T: +65 68 72 08 63

E: sales@observator.sg

**United Kingdom**

T: +44 (0)783 346 4884

E: info.uk@observator.com

**Welcome to the world of Observator**

Since 1924 Observator has evolved to be a trend-setting developer and supplier in a wide variety of industries. Originating from the Netherlands, Observator has grown into an internationally

oriented company with a worldwide distribution network and offices in Australia, Germany, the Netherlands, Singapore and the United Kingdom.

[www.observator.com](http://www.observator.com)