

CT2N Serie

WIPER CONTROL SYSTEM



USER MANUAL

1. General

CT2N is a microcontroller-based wiper control system for up to 5 wiper motors; it provides all the functions for a proper windscreen cleaning.

CT2N is composed by one (or more) control panels CP4PX (where 'X' stands for the number of wipers handled) and one relay box SRM2/3P or SRM4/5P depending on the number of wipers.

Control panel is connected to relay box by one serial cable (CAN BUS CABLE) with two 8 pole plugs. Every unit has two plugs (in parallel) and any one or both can be used.

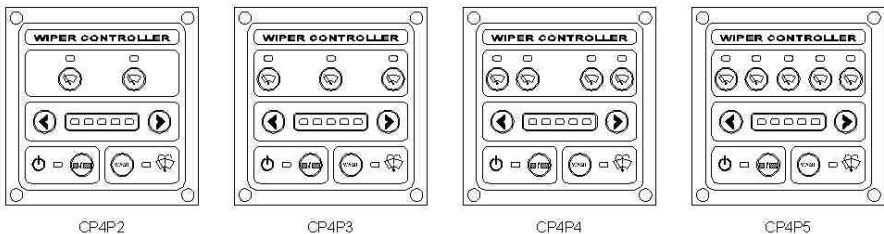

Features:

- Double voltage supply: 12V - 24V
- Fit for any d.c. motors (see output current) and for any kind of parking switch
- Activates/deactivates each wiper one by one
- **Synchronization in each selected mode**
- Three (four if one speed motors) intermittent settings
- Perfect self parking position due to "dynamic brake"
- Wipe/wash program
- Easy to install and to use
- Reliable

Standard supply includes:

- One CP4PX
- One SRMXP
- One cable for can bus connection (standard 5 meters) CAVOT8XX05
- 4 poles female connectors for SRMXP to motors connection (one for each motor)
- One female 6,3 mm fast-on terminal for washing pump connection
- Two (or four if more that 3 wipers) female 9,5 mm fast-on terminals for power supply connection
- User manual

2. Push button functions and signalings

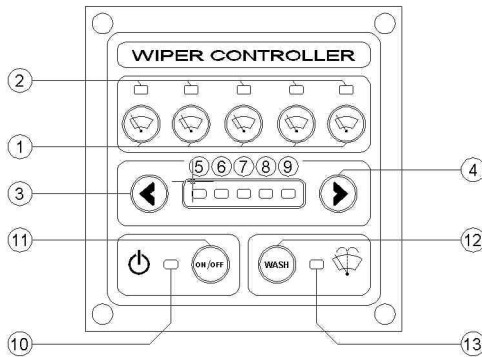

Fig. 1

With reference to fig. 1:

- 1 – single wiper ON/OFF button
- 2 – single wiper ON/OFF and fault led
- 3 – decrease speed / increase delay in intermittent mode
- 4 – increase speed / decrease intermittent delay
- 5,6,7,8,9 – selected mode led bar
- 10 – General ON/OFF led
- 11 – General ON/OFF button
- 12 – Wash cycle button
- 13 – Wash cycle signalling led

3. Operating mode

The operating mode available depends on the number of the motor's speeds.

If using 2 speed motors:

SPEED BAR	WAITING TIME	MODE
All leds OFF	-	Stand-by
Led 5 ON	8 seconds	Intermittent
Led 5+6 ON	4 seconds	Intermittent
Led 5+6+7 ON	2 seconds	Intermittent
Led 5+6+7+8 ON	-	Continuous (low speed)
Led 5+6+7+8+9 ON	-	Continuous (high speed)

If using 1 speed motors

SPEED BAR	WAITING TIME	MODE
All leds OFF	-	Stand-by
Led 5 ON	8 seconds	Intermittent
Led 5+6 ON	6 seconds	Intermittent
Led 5+6+7 ON	4 seconds	Intermittent
Led 5+6+7+8 ON	2 seconds	Intermittent
Led 5+6+7+8+9 ON	-	Continuous

4. Wipe / Wash program

By pressing the wash button, washing program will start.

| 3 sec. | 3 sec. | 4 sec. |

|=== Spray ===== Spray =====|
|===== Wipe ===== Wipe ===|

To increase wash timing and spray / wipe time, keep pressed the wash button.
After wipe/wash cycle, wipers will return to operate in the previous selected mode.

5. Failures and signalling

Wiper fault

A flashing of a wiper led indicates that CT2N detects an error on a wiper.

This may happen if:

- the parking switch is unconnected or damaged
- the motor doesn't run (internal self-resetting fuse in protection, motor unconnected or damaged)
- the motor doesn't run in FAST or in SLOW speed
- the motor can't be synchronized
- the motor connectors have been inserted after supplying power.

Communication error

A shifting effect of the mode bar led indicates that control panel CP4P can't communicate with the relay box; this may happen if the flat cable is damaged / improperly connected or if there are problem with can bus terminations.

6. Power supply

CT2N will operate correctly if powered from 10V to 30V DC.

Insert motor connectors BEFORE applying power supply.

When powered, CT2N will execute a lamp test and then will go in stand-by mode.

7. System configuration

The CT2N can handle up to 5 wipers.
 SRM2/3P relay box can handle 2 or 3 wipers, SRM4/5P can handle 4 or 5 wipers.
 The following configurations are available

No. of installed wipers	Control panel	Relay box
2	CP4P2	SRM2P
3	CP4P3	SRM3P
4	CP4P4	SRM4P
5	CP4P5	SRM5P

If user need two or more control stations, other control panels can be connected via CAN BUS by the 8 poles connectors (8 poles plug).
It's recommended to connect a control panel to a relay box and not to another control panel.
Connect a control panel directly to another control panel only if there aren't other possibilities.

8. System wiring (2 and 3 wipers)

IMPORTANT: protect the power supply line(s) by a thermal/magnetic circuit breaker. Thermal/magnetic circuit breaker and cables diameter must be sized according to the motor consumption and the regulations.

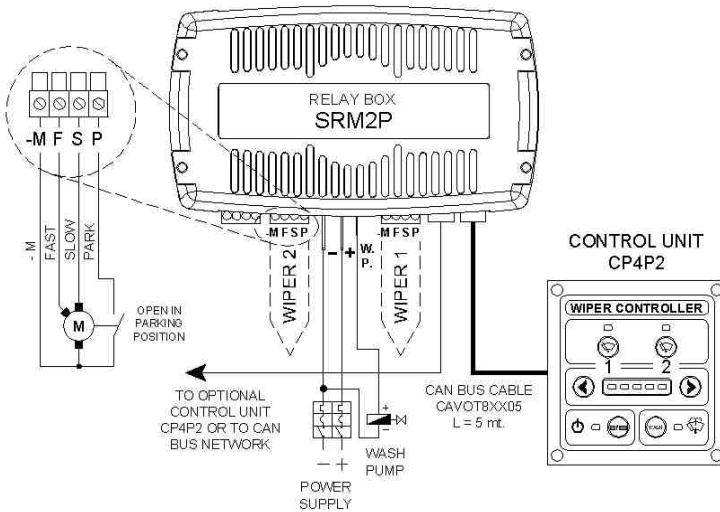

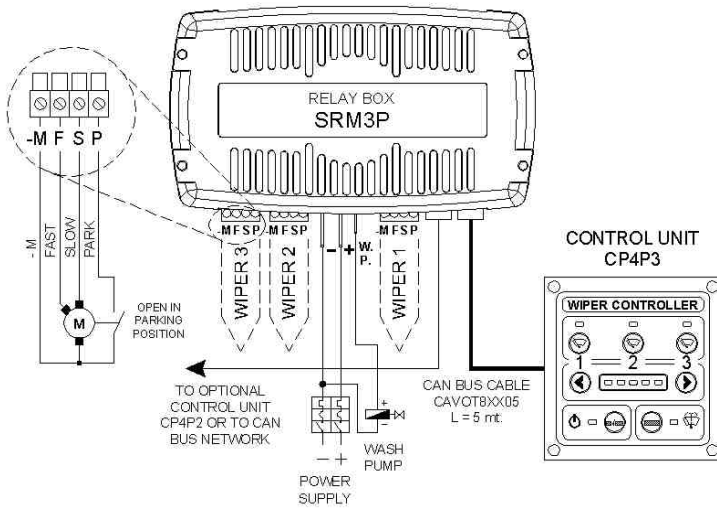

9. System wiring (4 and 5 wipers)

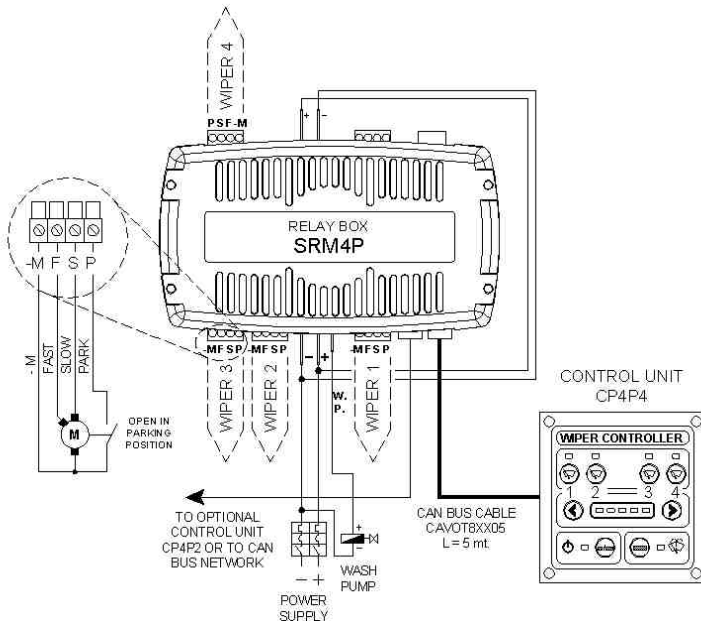

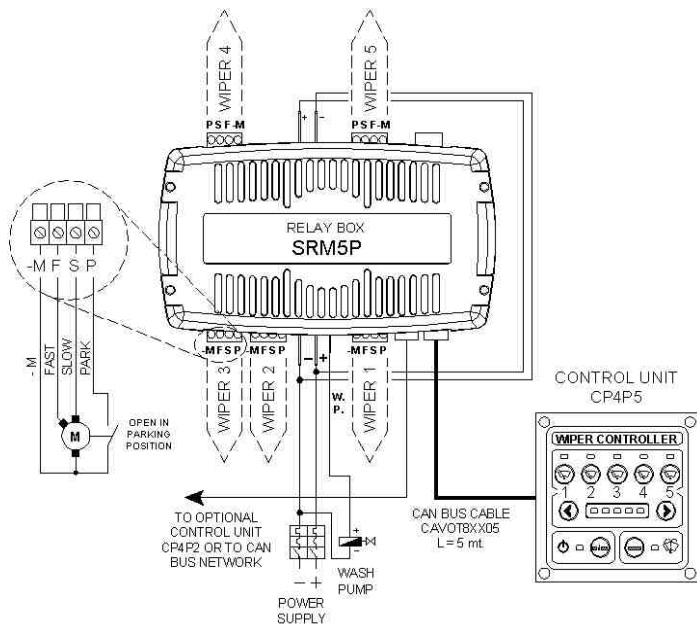

10. Relay box to control unit connections

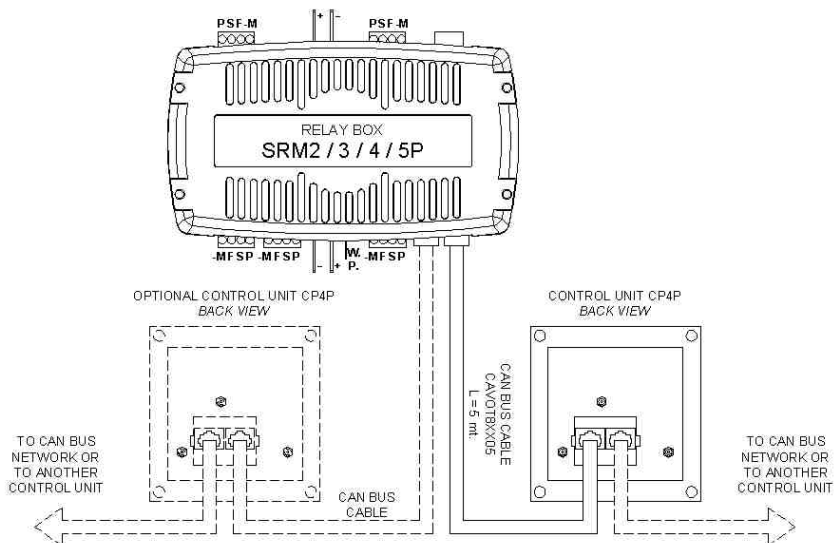

11. Control panel dimensions

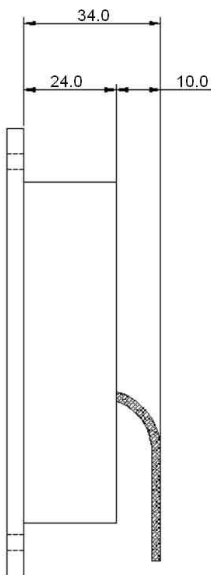
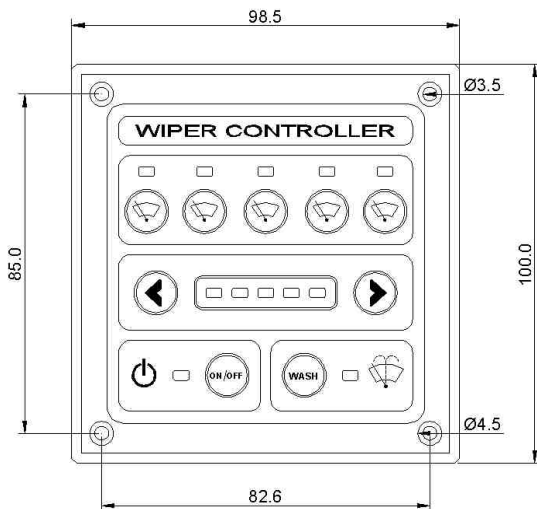

12. Cut out size of CP4PX

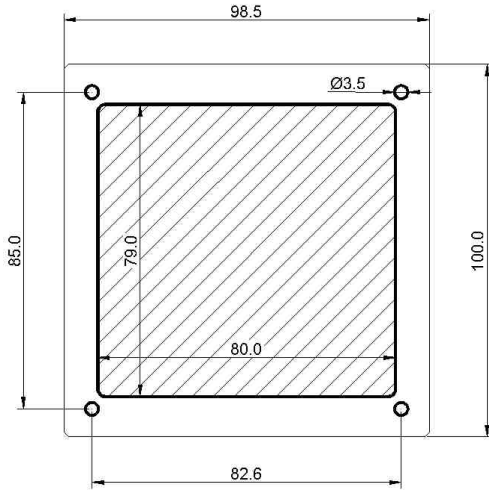

13. Relay box dimensions

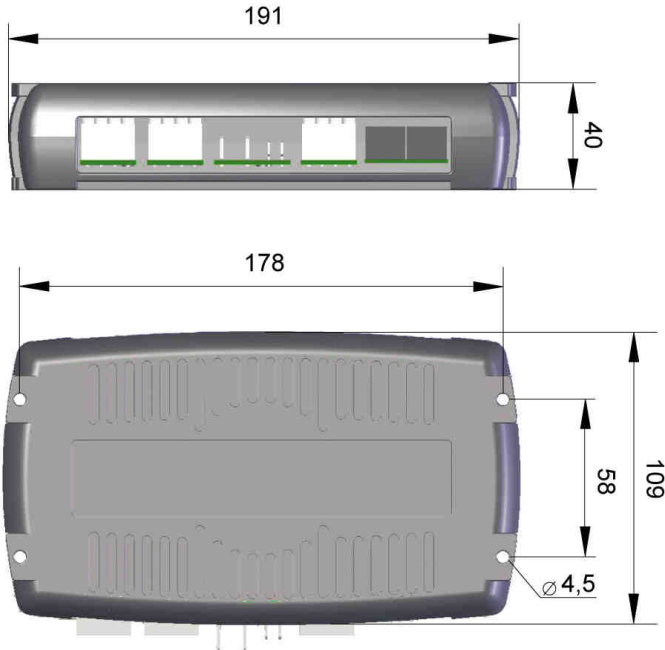

14. Technical data

CT2NX WIPER CONTROL SYSTEM			
Voltage supply	10V to 30V DC		
Internal fuses	12A self-resetting fuse for each motor		
Stand-by current	Less than 70 mA at 10V and less than 40 mA at 30V		
Protections	Polarity inversion		
Motors- output currents	Single or double speed – each motor 12 Amps max.		
Inputs	From 2 to 5 parking switches (open in park position)		
Outputs	From 2 to 5 SLOW speed I _{max} = 12A From 2 to 5 HIGH speed (if using two speed motors) I _{max} = 12A 1 wash pump (positive pole) SLOW I _{max} = 1A		
Functions	3 or 4 intermittent settings 1 or 2 continuous speeds (slow and high speed) Wash / wipe program		
Connections	Relay box SRM2/3P	Relay box SRM4/5P	Control panel CP4PX
	2 or 3 connectors with 4 poles no.2 - male 9,5 mm fast-on no.1 – male 6,3 mm fast-on no.2 connectors (jack) with 8 poles (can bus network)	4 or 5 connectors with 4 poles no.4 - male 9,5 mm fast-on no.1 – male 6,3 mm fast-on no.2 connectors (jack) with 8 poles (can bus network)	2 connectors with 8 poles (can bus network)
Case	Grey ABS		Metal case Frontal panel protection IP65
Working temperature	-25 °C / +50 °C		
Storage temperature	-30 °C / +80 °C		

15. Ordering information

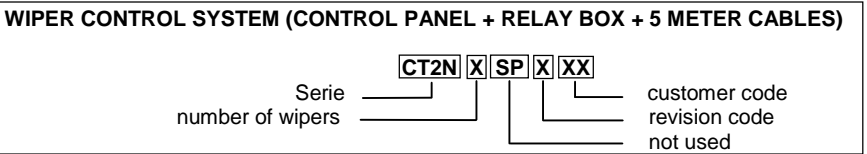

16. Optional / Spare parts

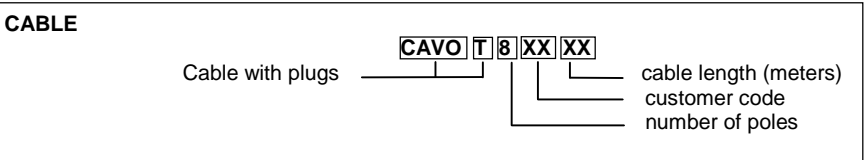
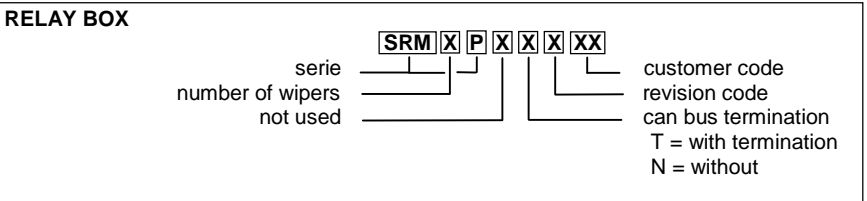
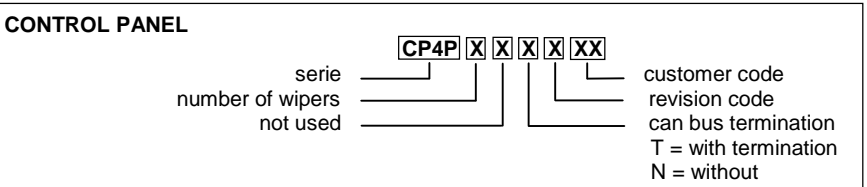

A progressive number could be added to part number

	<p>The manufacturer declare that the wiper control product of series CT2N is in conformity at requisition of electromagnetic compatibility and of security with directives 73/23/EEC, 89/336/EEC, 92/31/EEC and 93/68/EEC and 93/97/EEC and EN 60945 directives.</p>
--	--

All the normal precautions and the technical information contained in this manual must be used for a proper installation and use of the products. PINE S.r.l. is not responsible of any damage caused by improper use of the products. Warranty will not cover any damage caused by improper use of the products. The information contained herein is subject to change without notice. PINE shall not be liable for technical or editorial errors or omissions contained herein.

 **PINE** S.r.l.

Registered office: Via P. E. Venturini, 56 Chioggia - VE

Head office: Via Centro n. 49 frazione San Pietro – 30014

Cavarzere – Venice - Italy

Tel. +39 +426 357041

www.pinesrl.com info@pinesrl.com

- MADE IN ITALY -

**We represent this supplier.
For more information contact
Observator Vision:**

**T: +31 (0)85 0436000
E: vision@observator.com**

Zernikestraat 51
3316 BZ Dordrecht
The Netherlands

Welcome to the world of Observator

Since 1924 Observator has evolved to be a trend-setting developer and supplier in a wide variety of industries. Originating from the Netherlands, Observator has grown into an internationally

oriented company with a worldwide distribution network and offices in Australia, Germany, the Netherlands, Singapore and the United Kingdom.

www.observator.com